

TOP DEAL

NAŠI BESTSELLERI



KS TOOLS

WWW.KSTOOLS.COM – INOVACIJA JE NAŠA MISIJA!

Safety first

IZNIMNO VISOKA OPTERETIVOST
MAKSIMALNO OPTEREĆENJE
2600 KG
IZNIMNO VISOKA OPTERETIVOST



▶ **UKLJUČUJUĆI**

▶ **SA SIGURNOSNI
ELEMENT**

500.8400

Set univerzalnih zatezača opruga, 6-dijelni



Ø 80 - 160 MM



Ø 140 - 195 MM



samo **2993** HRK

▶ **MC PHERSON DRŽAČA OPRUGE**

▶ **UNIVERZALAN ZA 90% SVIH UOBIČAJENIH
OPRUGA ZA VOZILA U PUTNIČKOM I
TRANSPORTNOM PODRUČJU**



▶ **SA SIGURNOSNIM
UŽETOM**

897.7215

ECOline CRNA/CRVENA RADIONIČKA KOLICA SA 7 LADIGA I 215 PREMIUM ALATA

- idealan sastav seta za univerzalnu primjenu
- sa samouvlačenjem i SOFT-CLOSE funkcijom
- stabilna konstrukcija od čeličnog lima 0.8 mm debljine - kruto i nesavitljivo
- stranice sa četverokutnim rupama za stavljanje različitih dijelova pribora
- centralno zaključavanje svih ladicu pomoću cilindrične brave

ECO *Line*



215
-dijelni

max.
300 kg

max.
25 kg

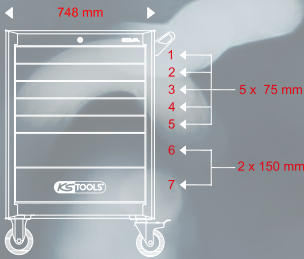
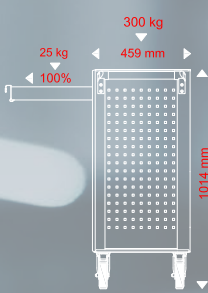

**Garan
ispra
oda**



713.0215
SET UNIVERZALNIH SUSTAVNIH ULOŽAKA
ZA 3 LADICA S 215 PREMIUM ALATOM

1 **711.0013**

⊖ 3/4/5/5/6,5/8mm ⊕ PH1/PH2/PH3

2 **711.0027**

6/7/8/9/10/11/12/
13/14/15/16/17/18/
19/21/22 mm 6x7/8x9/10x11/
12x13/14x15/16x17/
18x19/20x22 mm

3 **711.0179**

1/4" 3/8" 1/2"

⊖ 4 - 12 mm ⊖ 4 - 32 mm
⊕ PH0 - PH4 ⊕ E4 - E24
⊕ PZ0 - PZ4 ⊕ 1,3 - 14 mm
⊕ T5 - T70 ⊕ TS10 - TS40
⊕ TB5 - TB70 ⊕ M5 - M8
⊕ M5 - M9

ECO *Line*

+215
dijelova!

3743,00 *
HRK

*U cijene nije uračunat zakonom propisan porez na dodanu vrijednost.

STANDARD

SPECIAL

826.7215

RACINGline CRNA/CRVENA RADIONIČKA KOLICA SA 7 LADICA I 215 PREMIUM ALATA

- vrlo stabilna konstrukcija od čeličnog lima 0,9 mm debljine - kruto i nesavitljivo
- visoka stabilnost
- stranice sa četverokutnim rupama za stavljanje različitih dijelova pribora
- pojedinačno zaključavanje sprječava neželjeno otvaranje
- centralno zaključavanje svih ladica pomoću cilindrične brave

RACING *Line*



215
-dijelni



**Uključeno
odabir!**



713.0215

SET UNIVERZALNIH SUSTAVNIH ULOŽAKA ZA 3 LADICA S 215 PREMIUM ALATOM

1 711.0013

⊖ 3/4/5,5/6,5/8mm ⊕ PH1/PH2/PH3

2 711.0027

6/7/8/9/10/11/12/
13/14/15/16/17/18/
19/21/22 mm 6x7/8x9/10x11/
12x13/14x15/16x17/
18x19/20x22 mm

3 711.0179

1/4" 3/8" 1/2"

- ⊖ 4 - 12 mm
- ⊕ PH0 - PH4
- ⊗ PZ0 - PZ4
- ⊗ T5 - T70
- ⊗ TB5 - TB70
- ⊖ 4 - 32 mm
- ⊗ E4 - E24
- ⊖ 1,3 - 14 mm
- ⊗ TS10 - TS40
- ⊖ M5 - M8
- ⊗ M5 - M9

RACING *Line*

+ 215 dijelova! **4118,00** **HRK** *

*U cijene nije uračunat zakonom propisan porez na dodanu vrijednost.

826.7515

RACINGline CRNA/CRVENA RADIONIČKA KOLICA SA 7 LADICA I 515 PREMIUM ALATA

- idealan sastav seta za univerzalnu primjenu
- vrlo stabilna konstrukcija od čeličnog lima 0,9 mm debljine - kruto i nesavitljivo
- visoka stabilnost
- stranice sa četverokutnim rupama za stavljanje različitih dijelova pribora
- centralno zaključavanje svih ladicica pomoću cilindrične brave

RACING *Line*

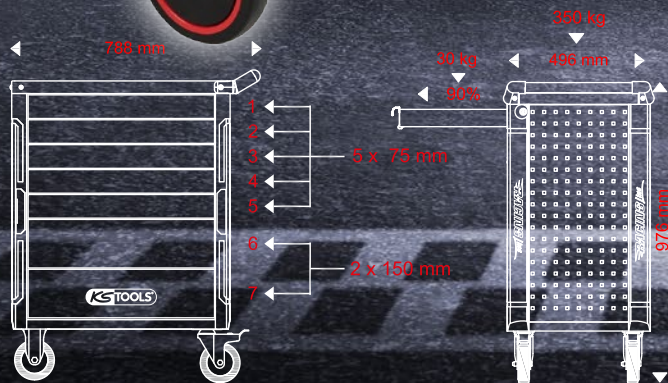

**PREKO
500
ALATA ZA 4 LADICE**

*U cijene nije uračunat zakonom propisan porez na dodanu vrijednost.

STANDARD

12V
SPECIAL



515
-dijelni

713.0515
SET UNIVERZALNIH SUSTAVNIH ULOŽAKA ZA 4 LADICA
S 515 PREMIUM ALATOM

1 711.1018



2 711.3035

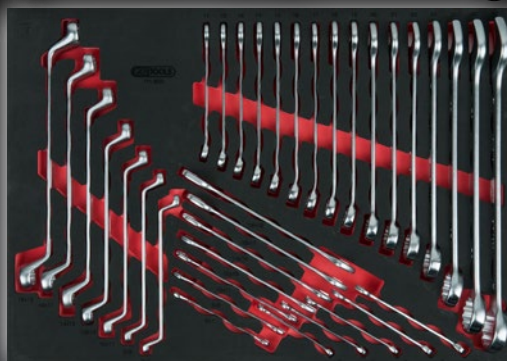

6/7/8/9/10/11/12/13/14/15/16/
17/18/19/21/22/24/27/30/32 mm 6x7/8x9/10x11/12x13/
14x15/16x17/18x19 mm

3 711.1059

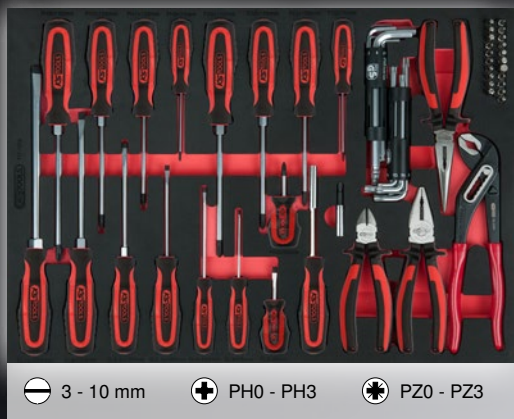

3 - 10 mm PH0 - PH3 PZ0 - PZ3

4 711.0195

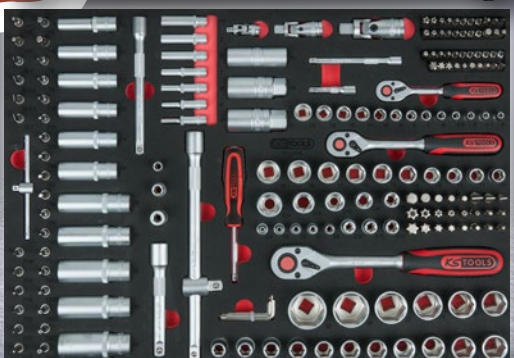

- 1/4": 4/4,5/5/5,5/6/7/8/9/10/11/12/13/14 mm 1/4": E4/E5/E6/E7/E8
- 3/8": 10/11/12/13/14/15/16/17/18/19 mm 3/8": E10/E11/E12/E14/
E16/E18
- 1/2": 10-11-12-13-14-15-16-17-18-19-20-21-
22-24-27-30-32 mm 1/2": E20/E24
- 1,3 - 1,5/2/2,5/3/4/5/6/7/8/10/12 mm
- T5/T6/T7/T8/T9/T10/T15/T20/T25/T27/T30/T40/T45/T50/T55/T60
- TB7/TB8/TB9/TB10/TB15/TB20/TB25/TB27/TB30/TB40/TB45/TB50/TB55/TB60
- 4/5,5/6,5/7/8/10/12 mm M5/M6/M8
- PH0/PH1/PH2/PH3/PH4 M5/M6/M7/M8/M9
- PZ0/PZ1/PZ2/PZ3/PZ4
- TS10/TS15/TS20/TS25/TS27/TS30/TS40/TS45

515 dijelova!



5618,00⁰⁰ HRK

*U cijene nije uračunat zakonom propisan porez na dodanu vrijednost.

826.7598

RACINGline CRNA/CRVENA RADIONIČKA KOLICA SA 7 LADICA I 598 PREMIUM ALATA

- idealan sastav seta za univerzalnu primjenu
- vrlo stabilna konstrukcija od čeličnog lima 0,9 mm debljine - kruto i nesavitljivo
- visoka stabilnost
- stranice sa četverokutnim rupama za stavljanje različitih dijelova pribora
- centralno zaključavanje svih ladicica pomoću cilindrične brave

598 dijelova!

STANDARD

1 711.0018 



2 711.1029 

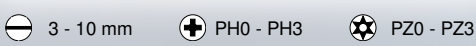
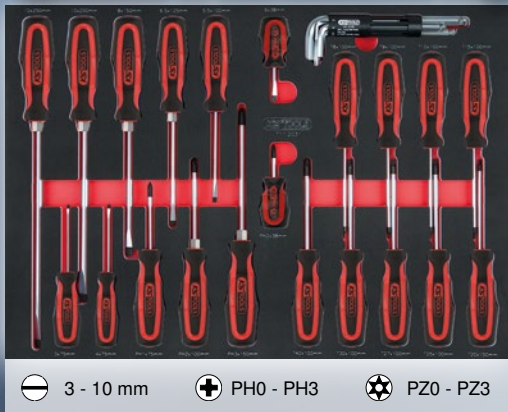

3 711.3035 

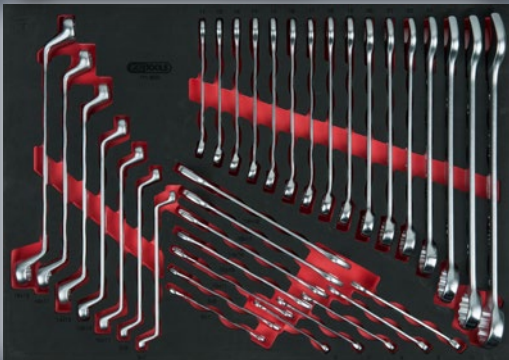

4 713.0101  **712.0001** 

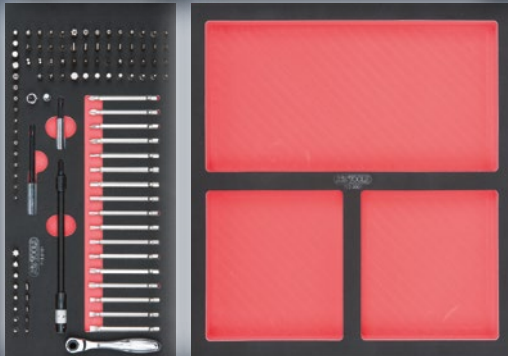

5 711.1012 



6 711.0195 

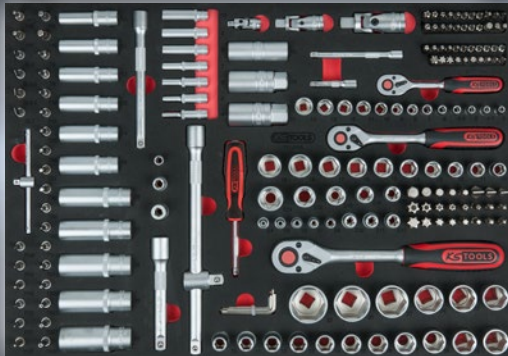

- | | | |
|-------------|--|--|
| 1/4" | <ul style="list-style-type: none"> 1/4": 4/4,5/5/5,5/6/7/8/9/10/11/12/13/14 mm 3/8": 10/11/12/13/14/15/16/17/18/19 mm 1/2": 10-11-12-13-14-15-16-17-18-19-20-21-22-24-27-30-32 mm | <ul style="list-style-type: none"> 1/4": E4/E5/E6/E7/E8 3/8": E10/E11/E12/E14/E16/E18 1/2": E20/E24 |
| 3/8" | | |
| 1/2" | <ul style="list-style-type: none"> 1,3 -1,5/2,2,5/3/4/5/6/7/8/10/12 mm T5/T6/T7/T8/T9/T10/T15/T20/T25/T27/T30/T40/T45/T50/T55/T60 TB7/TB8/TB9/TB10/TB15/TB20/TB25/TB27/TB30/TB40/TB45/TB50/TB55/TB60 4/5,5/6,5/7/8/10/12 mm M5/M6/M8 PH0/PH1/PH2/PH3/PH4 M5/M6/M7/M8/M9 PZ0/PZ1/PZ2/PZ3/PZ4 TS10/TS15/TS20/TS25/TS27/TS30/TS40/TS45 | |

713.0598
SET UNIVERZALNIH SUSTAVNIH ULOŽAKA ZA 6 LADICA S 598 PREMIUM ALATOM

SKORO 600 ALATA ZA 6 LADICA



12V SPECIAL

*U cijene nije uračunat zakonom propisan porez na dodanu vrijednost.



598
-dijelni

RACING Line



max.
350 kg

max.
30 kg

KSTOOLS

0
A
ICA

STANDARD

12V

SPECIAL

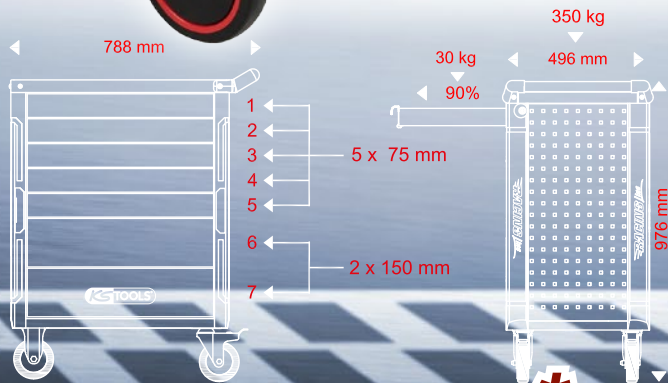

7493,00 HRK



*U cijene nije uračunat zakonom propisan porez na dodanu vrijednost.

ERGOTORQUE® precision MOMENT KLJUČ S OKRETNIM GUMBOM I PREBACIVOM ZAPORNOM GLAVOM

- preciznost okidanja: $\pm 3\%$ tolerancija od podešene vrijednosti skale
- točna ponavljanja i preciznost za minimalno 5.000 promjena tereta
- za kontrolirano desno i lijevo zatezanje
- jasno čujno i osjetno okidanje okretnog momenta preko okidanja kratkim putem
- brzo i sigurno podešavanje okretnog momenta okretanjem ručke

Artikl	Okretni Moment:			
516.1402	1/4"	1-5 Nm	HRK	593,00
516.1412	1/4"	5-25 Nm	HRK	593,00
516.1422	3/8"	10-50 Nm	HRK	593,00
516.1432	1/2"	20-100 Nm	HRK	668,00
516.1442	1/2"	40-200 Nm	HRK	668,00
516.1472	1/2"	60-320 Nm	HRK	743,00
516.1482	1/2"	80-420 Nm	HRK	818,00
516.1490	3/4"	110-550 Nm	HRK	3368,00
516.1493	3/4"	150-750 Nm	HRK	3593,00
516.1495	1"	200-1000 Nm	HRK	4118,00



i mikrometerskom skalom



REPOZICIONI KVADRATNI POGON

Promjena smjera okretanja vrši se jednostavnim repozicioniranjem kockastog pogona

Certificirana preciznost



od **593,00*** HRK

SET NASADNIH KLJUČEVA



- KOMFORNI**
- 4 - 4,5 - 5 - 5,5 -
6 - 7 - 8 - 9 -
10 - 11 - 12 -
13 - 14 - 15 -
16 - 17 - 18 -
19 - 20 - 21 -
22 - 24 - 27 -
30 - 32 mm



195
-dijelni

1/4" 3/8" 1/2"
mat satinirano

kromirano, visokog sjaja

917.0795 **668,00*** HRK

918.0795 **668,00*** HRK

SET NASADNIH KLJUČEVA



- KOMPLETNI**
- 4 - 4,5 - 5 - 5,5 -
6 - 7 - 8 - 9 - 10 -
11 - 12 - 13 - 14 -
15 - 16 - 17 - 18 -
19 - 20 - 21 - 22 -
24 - 27 - 30 - 32 mm



216
-dijelni

1/4" 3/8" 1/2"
mat satinirano

kromirano, visokog sjaja

917.0216 **1043,00*** HRK

918.0216 **1043,00*** HRK

UNIVERZALNI ALAT-SET



- PAMETNI**
- 4 - 4,5 - 5 - 5,5 -
6 - 7 - 8 - 9 - 10 -
11 - 12 - 13 - 14 -
15 - 16 - 17 - 19 -
20 - 21 - 22 - 24 -
27 - 30 - 32 mm



97
-dijelni

1/4" 1/2"
mat satinirano

kromirano, visokog sjaja

917.0797 **1043,00*** HRK

918.0797 **1043,00*** HRK

911.0721

SET NASADNIH KLJUČEVA



- IZDRŽLJIVI**
- 19 - 21 - 22 -
23 - 24 - 26 -
27 - 29 - 30 -
32 - 35 - 36 -
38 - 41 - 46 -
50 mm



21
-dijelni

3/4"

1343,00* HRK

*U cijene nije uračunat zakonom propisan porez na dodanu vrijednost.

STANDARD

12V SPECIJAL

911.0727

UNIVERZALNI KOMPLET ALATA



127
-dijelni

SVESTRANI

- 4 - 4,5 - 5 - 5,5 - 6 -
- 7 - 8 - 9 - 10 - 11 -
- 12 - 13 - 14 - 16 -
- 17 - 18 - 19 - 20 -
- 22 - 24 - 27 - 30 -
- 32 mm

1/4"

1/2"

2243,00* HRK

940.0047

UNIVERZALNI ALAT-SET



ČVRSTA SVESTRANOST

47
-dijelni



- 10 - 11 - 12 - 13 - 14 -
- 15 - 16 - 17 - 18 - 19 -
- 20 - 21 - 22 - 24 mm

1/2"

968,00* HRK

MODIFIX® MINI USTAVLJAČ SA ZAOKRETNOM GLAVOM I T DRŠKOM



- prebacivo
- fino nazubljen 72-zubni zaporni mehanizam
- multifunkcijska primjena
- zaokretna vilica podesiva za konstantno dobru zategnutost zaokretne glave

Primjena: ustavljački ključ s T ručkom / odvijač s ustavljačem. podesivo u 2 položaja 0° + 90°

MODIFIX



2 USTAVLJAČKA KLJUČA U JEDNOM!

Artikl	Kockasti pogon u colima:	HRK
914.1405	1/4"	263,00
914.3815	3/8"	293,00

1/4" 3/8"

od **263,00*** HRK

920.0002

SLIMPOWER USTAVLJAČKI KLJUČ-SET



- prema DIN 3122 / ISO 3315
- kvadratni pogon prema DIN 3120 / ISO 1174 s kugličnim zapornikom
- prebacivo
- ekstremno uska glava
- fino nazubljen 72-zubni zaporni mehanizam

2
-dijelni



102 Nm

710 Nm

1/4" 1/2"

368,00* HRK

911.0009

NAGIBNI PRODUŽETAK-SET



- unutarnji kvadrat prema DIN 3120 / ISO 1174 s kugličnim žlijebom
- nagibni četverokutni pogon sa zapornikom za kuglu
- nagibni kut na svaku stranu 8°
- za ručni pogon
- mat satinirano

9
-dijelni



- 1/4": 50 - 100 - 250 mm
- 3/8": 45 - 75 - 150 - 200 mm
- 1/2": 125 - 250 mm

1/4" 3/8" 1/2"

188,00* HRK

917.0707

SET ADAPTERA ZA POVEĆANJE I REDUKCIJU



- prebacivo
- fino nazubljen 72-zubni zaporni mehanizam
- multifunkcijska primjena
- zaokretna vilica podesiva za konstantno dobru zategnutost zaokretne glave

7
-dijelni



1/4" 3/8" 1/2" 3/4"

113,00* HRK

*U cijene nije uračunat zakonom propisan porez na dodanu vrijednost.

515.0055

SET ŠESTEROKUTNIH NASADNIH KLJUČEVA ZA MOTORNA VOZILA, EKSTRA KRATAKI

- 6-kutni
- vrlo plosnat model
- prema DIN 3129 / ISO 2725-2
- unutarnji četverkut prema DIN 3121 / ISO 1174
- kratka varijanta



15
-dijelni

**EKSTRA
KRATAK**

10 - 11 - 12 - 13 - 14 - 15 -
16 - 17 - 18 - 19 - 20 - 21 -
22 - 23 - 24 mm



368,00* HRK

515.0100

TERETNI SET ADAPTERA ZA POVEĆANJE I REDUKCIJU

- idealan sastav seta prilagodnika i kuglastih zglobova
- krom-molibden
- u stabilnom plastičnom koferu s kotačićima



9
-dijelni

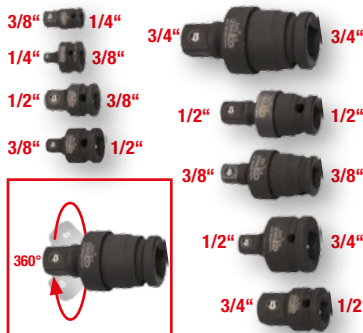

1/4" 3/8" 1/2" 3/4"

593,00* HRK

503.4565

4 U 1 GEARplus® ZGLOBNI DVOSTRUKI OKASTI KLJUČ SA ZAPOROM, PREBACIV

- bočno proklizavanje-profil
- ravni oblik
- precizno nazubljeno s 72 zupca
- četiri različite širine ključeva
- s prebacivačkom polugom



10 19
4/1
13 17

132,00* HRK

517.0052

SET OKASTIH KLJUČEVA, SAVIJEN

- bočno proklizavanje-profil
- položaj čeljusti 15° savijen
- prsten čeljusti 15° savijen
- polirane glave
- mat satinirano



12
-dijelni



8 - 9 - 10 - 11 - 12 -
13 - 14 - 15 - 16 -
17 - 18 - 19 mm

218,00* HRK

517.0043

SET OKASTIH KLJUČEVA, SAVIJEN

- bočno proklizavanje-profil
- položaj čeljusti 15° savijen
- prsten čeljusti 15° savijen
- polirane glave
- mat satinirano



21
-dijelni



6 - 7 - 8 - 9 - 10 -
11 - 12 - 13 - 14 -
15 - 16 - 17 - 18 -
19 - 20 - 21 - 22 -
24 - 27 - 30 - 32 mm

593,00* HRK

503.4250

GEARplus® OKASTO-VILIČASTI KLJUČ SA ZAPOROM-SET

- bočno proklizavanje-profil
- položaj čeljusti 15° savijen
- ravni oblik
- precizno nazubljeno s 72 zupca
- vrlo fino satinirano



10
-dijelni



8-10-11-12-13-
14-16-17-18-19 mm

743,00* HRK

503.4960

GEARplus® RINGSTOP OKASTO-VILIČASTI KLJUČ SA ZAPOROM-SET, PREBACIV

- bočno proklizavanje-profil
- položaj čeljusti 15° savijen
- glava ustavljača 15° savijena
- s prebacivačkom polugom
- nasadni ključevi s prolaznom rupom



30
-dijelni

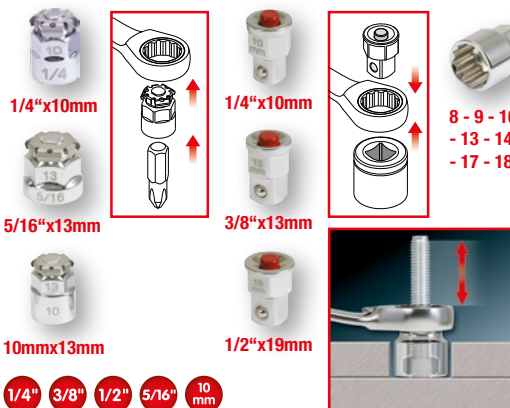

8 - 9 - 10 - 11 - 12 -
13 - 14 - 15 - 16 -
17 - 18 - 19 mm

1118,00* HRK

577.0352

VILIČASTI VALJKASTI KLJUČ S USTAVLJAČEM

- DIN 3117 oblik A
- položaj čeljusti 15° savijen
- švedski model
- s integriranom zapornom funkcijom
- valjak s hodom nalijevo

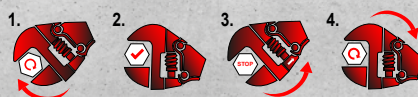

0 - 32 mm

143,00* HRK

*U cijene nije uračunat zakonom propisan porez na dodanu vrijednost.

918.1495

CHROMEplus® BIT-NASADNI KLJUČ SA ZAPOROM

- za bitove s vanjskim šesterokutnim pogonom prema DIN 3126 / ISO 1173 - C 6,3
- prebacivo
- precizno nazubljeno s 72 zupca
- s 2-komponentnom ručkom
- kromirano, visokog sjaja



113,00* HRK



911.2060

BIT-SET

- za ručni pogon i električne odvijače
- s magnetnim brzozamjenskim držačem bitova i 1/4" prilagodnikom nasadnih ključeva
- idealno za navojne spojeve u obrtništvu i industriji
- precizani i uredan raspored najčešće korištenih 1/4" bitova
- specijalni čelik za alate

1/4"

- PH1 - PH2 - PH3
- 2x PZ1 - 2x PZ2 - 2x PZ3
- 5,5 - 6,5 - 8 mm
- 4 - 5 - 6 mm
- 2x TB10 - 2x TB20 - 2x TB40 - 3x TB15 - 3x TB25 - 3x TB30



72,00* HRK



32 -dijelni

514.1148

MAGNETNI BRZOPOTEZNI DRŽAČ BITOVA S ČAHUROM, EKSTRA DUGAČAK

- s funkcijom brze zamjene i zaključavanjem
- magnetno
- s okretnom čahurom
- za 1/4" bitove s vanjskim šesterokutnim pogonom prema DIN 3126 / ISO 1173 - C 6,3
- za ručnu aktivaciju, električne odvijače i bušilice



143,00* HRK



918.3005

TORSIONpower BOKS BIT NASADNIH KLJUČEVA

- za ručni pogon i električne odvijače
- bitovi s kodiranjem u boji
- 180° zakretna glava
- produžetak se može koristiti i kao T ručka
- fino nazubljen 72-zubni zaporni mehanizam



- 4 - 6 mm
- PH1 - PH2 - PH3
- PZ1 - PZ2 - PZ3
- 3 - 4 - 5 - 6 mm
- T10 - T15 - T20 - T25 - T27 - T30 - T40

MULTITALENT SA NASADNIM KLJUČEVIMA

- 5 - 6 - 7 - 8 - 9 - 10 - 11 - 12 - 13 - 14 mm



368,00* HRK



33 -dijelni

159.0010

ERGOTORQUEplus® ODVIJAČ-SET

- s 2-komponentnom ručkom
- optimalan prijenos okretno snage
- ojačani rezač
- kromiran i ojačan vrh
- rezač od krom vanadija

PROREZ & KRST



3 - 4 - 5,5 - 6,5 mm PH1 - PH2

113,00* HRK



6 -dijelni

159.2051

REVOLVER-USTAVLJAČKI ODVIJAČ ZA BITOVE

- sa zapornom funkcijom
- precizno nazubljeno s 72 zupca
- drška s dvostrukom funkcijom (standardna i revolver drška)
- 40 Nm maksimalan okretni moment
- integrirano spremište za bitove



- 5,5 - 6,5 mm
- PH1 - PH2
- PZ1 - PZ2

1/4"

132,00* HRK



7 -dijelni

*U cijene nije uračunat zakonom propisan porez na dodanu vrijednost.

ERGOTORQUEplus® ODVIJAČ-SET

- s 2-komponentnom ručkom
- optimalan prijenos okretne snage
- ojačani rezač
- kromiran i ojačan vrh
- rezač od krom vanadija

TORX

6
-dijelni

T10
T15
T20
T25
T30
T40



TB10
TB15
TB20
TB25
TB30
TB40



159.0030 **113,00*** HRK 159.0040 **113,00*** HRK



159.0100

ERGOTORQUEplus® ODVIJAČ I BIT-SET

- s 2-komponentnom ručkom
- optimalan prijenos okretne snage
- s najčešće korištenim 1/4" bitovima, držačem bitova i bit odvijačem vijaka
- ojačani rezač
- kromiran i ojačan vrh

39
-dijelni



- 3 - 4 - 5,5 - 6
- 6,5 - 8 - 10 mm
- PH0 - PH1
- PH2 - PH3
- PZ0 - PZ1
- PZ2 - PZ3
- 2 - 2,5 - 3 - 4
- 5 - 6 - 8 mm
- T10 - T15 - T20 - T25
- T27 - T30 - T40
- TB10 - TB15 - TB20 - TB25
- TB27 - TB30 - TB40

293,00* HRK



151.1150

ERGOTORQUE®max SET ODVIJAČA S UDARNOM KAPOM

- sa šestorokutnim pogonom
- s ustavljačem s T-drškom
- zaštitna udarna kapa na kraju ručke
- optimalan prijenos okretne snage
- ojačani rezač

- 3,5 - 5,5 - 6 - 7 - 8 - 10 mm
- PH0 - PH1 - PH2 - PH3 - PH4



1/4"



13
-dijelni

443,00* HRK



151.4880

SET TORX KUTNIH STEZNIH KLJUČEVA, DUGI

- duga varijanta
- ojačano
- mat kromirano
- specijalni čelik za alate
- u stabilnom preklopnom držaču



10
-dijelni

T8 - T10 - T15 - T20 - T25 - T27 - T30 - T40 - T45 - T50



152 mm

94,00* HRK



151.5000

SET KUTNIH STEZNIH KLJUČEVA S UNUTARNJIM ŠESTEROKUTOM I KUGLASTOM GLAVOM, DUGI

- duga varijanta
- s kuglastom glavom na dugom kraju
- idealno za teško pristupačne vijke
- u stabilnom preklopnom držaču
- ojačano



10
-dijelni

1,5 - 2 - 2,5 - 3 - 4 - 5 - 6 - 7 - 8 - 10 mm



180 mm

94,00* HRK



115.1197

POWER GRIP KLIJEŠTA

- kovane čeljusti za hvatanje
- sprječava isklizavanje i prilikom velikih sila
- precizno podešavanje veličina preko kotača za podešavanja
- za okrugli i ravan materijal



0 - 50 mm

220 mm

113,00* HRK



*U cijene nije uračunat zakonom propisan porez na dodanu vrijednost.

STANDARD

SPECIAL

151.8150

KUTNI STEZNI INBUS KLJUČ S KUGLIČNOM GLAVOM, T-DRŠKA-SET

- s kuglastom glavom na dugom kraju
- idealno za teško pristupačne vijke
- ojačano
- specijalni čelik za alate
- u stabilnom plastičnom koferu



9
-dijelni



2 - 2,5 - 3 - 4 - 5 -
6 - 8 - 10 - 12 mm

293,00*
HRK

151.8160

TORX KUTNI STEZNI KLJUČ SA S-DRŠKOM-SET S RUPOM

- rupa na kraćem kraju
- s 2-komponentnom ručkom
- ojačano
- specijalni čelik za alate
- u stabilnom plastičnom koferu



9
-dijelni



TB10 - TB15 - TB20 -
TB25 - TB27 - TB30 -
TB40 - TB45 - TB50

293,00*
HRK

118.0015

MINI REZAČ TIPLI, SAMOODVAJAJUĆI

- učinkovitost rezanja 60-63 HRC
- glava noža od plemenitog specijalnog čelika
- induktivno ojačane precizne oštrice
- fosfatiziran
- krom-molibden

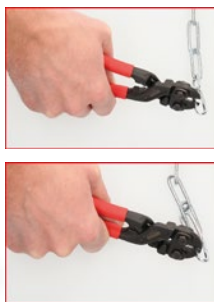

205 mm / 8"

14 mm

60-63 HRC

188,00*
HRK

111.3550

JEDNORUČNA CJEVASTA KLIJEŠTA S PODESIVOM GLAVOM

- tip „Stilson“
- aluminijsko lijevano tijelo
- bezstupanjski podesivo preko zupčaste matice
- 160° zakretna drška
- aluminijska drška



250 mm / 10"

0 - 38,1 mm

1 1/2"

293,00*
HRK

150.9540

KLIJEŠTA ZA ZAKOVICE

- odgovara za maskirne zakovice
- 360° okretna glava
- za teško pristupačna područja
- usko tijelo kliješta

maskirne zakovice:
2,4 - 3,2 - 4,0 - 4,8 mm



290 mm

**MASKIRNE ZAKOVICE:
2,4 - 3,2 - 4,0 - 4,8 MM**

218,00*
HRK

970.0150

ASORTIMAN MASKIRNIH ZAKOVICA

- čelični klin za obilježavanje
- isporuka u plastičnom koferu



400
-dijelni



100 x 2,4 mm
100 x 3,2 mm
100 x 4,0 mm
100 x 4,8 mm

57,00*
HRK

*U cijene nije uračunat zakonom propisan porez na dodanu vrijednost.

115.1400

UNIVERZALNI ALAT ZA KRIMPANJE-SET S AUTOMATSKIM KLIJEŠTIMA ZA SKIDANJE IZOLACIJE

- iznimno izdržljiva i pouzdana kliješta za krimpavanje
- mogućnost otključavanja u slučaju eventualnog pogrešnog rukovanja
- optimalan rezultat krimpavanja pomoću preciznih profila
- sa zapornom funkcijom
- laka zamjena uložaka za krimpavanje pomoću brzopotezne mehanike zamjene



283
-dijelni

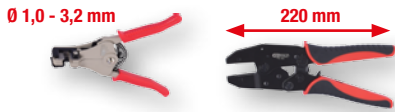

- Umetak za krimpavanje za izolirane kableske stopice
- Umetak za krimpavanje za neizolirane kableske omče
- Umetak za krimpavanje za ravne utikače 4,8 i 6,3 mm
- Umetak za krimpavanje za čahure žila
- Umetak za krimpavanje za koaksijalne utikače



1193,00*
HRK

960.1200

MALA LEMILICA

- mikro lemilica na plin do 1300°C / 2450°F
- s Piezo paljenjem
- optimalna za fine radove lemljenja
- punjenje s uobičajenim plinom za upaljače / ISO butanom
- s postoljem stola



SA PIEZO PALJENJEM

263,00*
HRK

960.1160

MIKRO LEMLJENJE-SET

- mikro lemilica na plin do 1300°C / 2450°F
- s Piezo paljenjem
- dovod plina bezstupanjnski podesiv
- punjenje s uobičajenim plinom za upaljače / ISO butanom
- s različitim nastavcima, namotajima žice za lemljenje, špužvom za lemljenje



11
-dijelni

SA PIEZO PALJENJEM



293,00*
HRK

911.2175

ODVIJAČ ZA PRECIZNU MEHANIKU-SET

- sa zamjenjivim okretnim bitovima
- s brzookretnom završnom kapom
- sa stezaljkom za grudni džep
- ručka od plastike
- 4 mm bitovi od specijalnog čelika



4
-dijelni

4U1

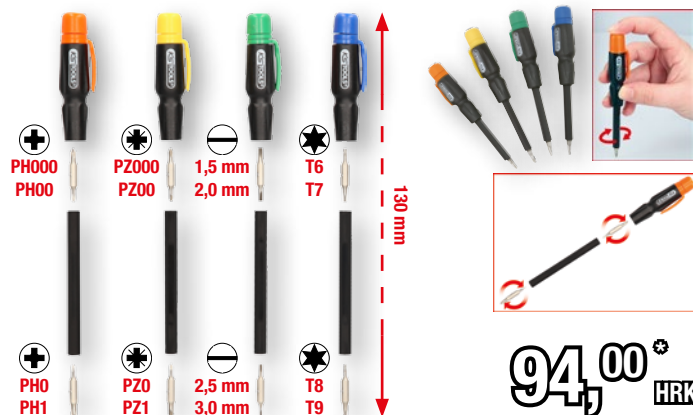

94,00*
HRK

550.1080

MAGNETNI I KUKASTI ALAT-SET

- idealno za skidanje i stavljanje O-prstena i brtvi
- s teleskopskim magnetnim dodatkom i zamjenjivom kukom
- polica s ručkom za različite dodatke
- specijalni čelik za alate



6
-dijelni



143,00*
HRK

300.0532

DIGITALNI KLIZNI MJERAČ 0 - 150 MM

- s vijkom za pričvršćivanje i finim namještanjem valjaka
- za vanjska, unutarnja, postupna i dubinska mjerenja
- mm/col prebacivanje
- reset (nuliranje) moguć na svim pozicijama
- nehrđajući čelik



SA DIGITALNIM ZASLONOM



188,00*
HRK

*U cijene nije uračunat zakonodavni porez na dodanu vrijednost.

STANDARD

12V
SPECIAL

117.0610

SET VDE ODVIJAČA S BRZAMJENSKIM OŠTRICAMA

- izolirano prema IEC 60900
- s automatskim zaključavanjem
- oštrice se čvrsto drže u ručki
- optimalan prijenos okretne snage
- s 2-komponentnom ručkom

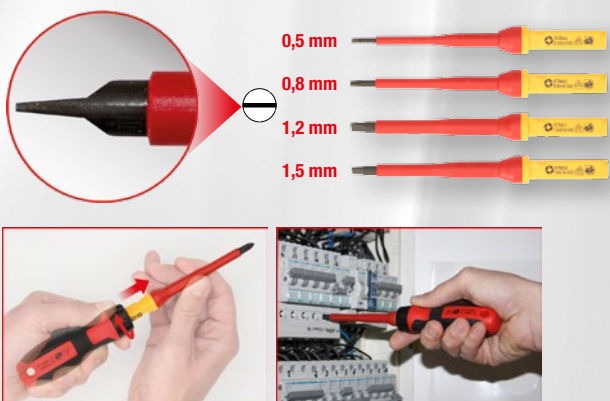

13
-dijelni

188,00* HRK

150.1495

DIGITALNI MULTIMETAR S ISPITNIM VRHOVIMA

- solidan multimetar s osnovnom mjernom funkcijom
- set mjernih vodova s ispitnim vrhom (crveno/crno)
- sa stopom s gumenom zaštitom

Funkcije:

- Mjerenje istosmjernog i izmjeničnog napona
- Mjerenje istosmjerne i izmjenične struje
- Mjerenje otpora
- Kontrola dioda (sa zvučnim signalom)
- Ispitivanje kontinuiteta (sa zvučnim signalom)
- Data-Hold funkcija
- Kontrolni indikator baterije



MULTITALENAT



TEHNIČKI PODACI:

Osigurač S1 (fina struja):	250mA/600V; 10A/600V
Radna temperatura:	0° do +40°C (32° do 104° F)
Istosmjerna struja:	20 µA - 10 A
Naizmjenični napon:	200 V - 600 V
Mjerenje otpora:	200 Ohm - 2 MOhm

143,00* HRK

500.7195

USB AKU ODVIJAČ ZA PRECIZNU MEHANIKU

- idealno za radove neovisno o mreži
- mala težina
- s praktičnom funkcijom prebacivanja lijevo/desno
- litij-ionske punjive baterije visokih performansi
- funkcija brzog punjenja (0,5 - 1 sat)



SA BITOVIMA
20x4 mm

293,00* HRK

*U cijene nije uračunat zakonom propisan porez na dodanu vrijednost.

700.1200

HIDRAULIČKI UNIVERZALNI SET SKIDAČA, 2+3-KRAKI

- neznatna opasnost od isklizavanja uslijed automatskog zatvaranja kraka za skidanje
- moguće 8 varijanti skidanja
- iznimno izdržljivo vreteno s inдукtivno ojačanim navojem
- potrebna neznatna snaga
- specijalni čelik za alate

HIDRAULIČNO, PRAKTIČNO, DOBRO!



22
-dijelni



Ø max. 105 mm

4" - 6" - 8"



20 - 35 - 85 mm

235 mm

185 mm

10 t. AG 1.1/2" x 16G

2018,00^{*} HRK

150.1305

ODVIJAČ NAVOJA-SET

- obiman sastav seta
- za uklanjanje slomljenih navojnih tipli i vijaka
- bez oštećenja navoja
- samo neznatno proširenje navojnih tipli preko specijalno profiliranih klinova za odvijanje
- za vijke i tiple M5 - M16

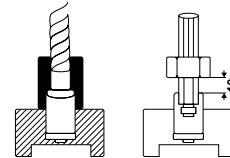

25
-dijelni

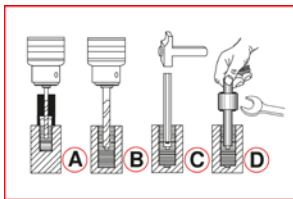

Führungshülse drill guide	Hülse Innen-Ømm guide	vorbohren Ømm pre-drilling	aufbohren re-drilling	Stift pin	Art.Nr. Stift No. Pin	Mutter D nut D	Art.Nr. Mutter nut D	Stift + Mutter pin + nut
150.0501	4,0 / 3,2	3,2	-	3,2	150.0521	SW 10	150.0511	150.0511S
150.0502	4,8 / 3,2	3,2	-	3,2	150.0521	SW 10	150.0511	150.0511S
150.0503	4,8 / 3,2	3,2	4,8	4,8	150.0522	SW 11	150.0512	150.0512S
150.0504	4,8 / 3,2	3,2	4,8	4,8	150.0522	SW 11	150.0512	150.0512S
150.0505	6,0 / 4,8	4,8	6,4	6,4	150.0523	SW 13	150.0513	150.0513S
150.0506	7,0 / 4,8	4,8	6,4	6,4	150.0523	SW 13	150.0513	150.0513S
150.0507	7,0 / 4,8	4,8	8,0	8,0	150.0524	SW 14	150.0514	150.0514S
150.0508	7,0 / 4,8	4,8	8,7	8,7	150.0525	SW 17	150.0515	150.0515S
150.0509	9,0 / 6,5	6,4	8,7	8,7	150.0525	SW 17	150.0515	150.0515S
150.0510	9,5 / 6,5	6,4	8,7	8,7	150.0525	SW 17	150.0515	150.0515S

**OBAVEZAN DIO
SVAKE RADIONICE**

4 / 3,2 - 9,5 / 6,5 mm
5/32" / 1/8" - 3/8" / 1/4"

3,2 - 8,7 mm
1/8" - 11/32"

3,2 - 8,7 mm
1/8" - 11/32"

10 - 17 mm

263,00^{*} HRK

150.7060

SET ODVIJAČA ZA TORX I ŠESTEROKUTNE VIJKE

- idealno za odvijanje vijaka i klinova čija je glava oštećena ili pohabana
- specijalni, lijevi urezni navoj s konusnim rezanjem za Torx vijke i specijalno oblikovan odvijlač za vijke s unutarnjim šesterokutom
- s TORSIONpower bitovima za Torx vijke i vijke s unutarnjim šesterokutom
- bitovi s torzionom zonom za prigušivanje vrhova okretnog momenta
- duži vijek trajanja



34
-dijelni

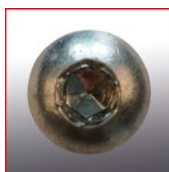
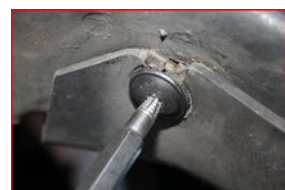

TE10 - TE15 - TE20 - TE25 - TE27
- TE30 - TE40 - TE50 - TE55

HE1,5 - HE2 - HE2,5 - HE3 - HE4 - HE5 - HE6 - HE8 - HE10

1,5 - 2 - 2,5 - 3 - 4 - 5 - 6 mm

10 mm

T10 - T15 - T20 - T25 - T27 - T30 - T40 1/4"



ODVIJA SVAKI VIJAK

1/4" 10 mm

293,00^{*} HRK

*U cijene nije uračunat zakonom propisan porez na dodanu vrijednost.

dvostruku kameru
0° + 90°
Ø 6,0 mm

HD

Senzacija!

vjerovatno najmanja dualna
dvostruka HD-kamera na svijetu!

dvostruku kameru
0° + 90°
Ø 4,5 mm

Ø 6,0 MM

Ø 4,5 MM

Opcija 1:

sa sondom Ø6,0 mm

Opcija 2:

sa sondom Ø4,5 mm



5
-djelni

550.7500

1493,00* HRK



7
-djelni

550.7530

1868,00* HRK



TEHNIČKI PODACI:

monitor:	3,5"	Trajanje rada:	oko 150 min	Aku-baterije:	1500 mAh	Radna temperatura:	-10°C do +60°C
format snimanja slike:	JPEG	priključak:	USB 2.0	Aku materijal:	Li-polimer	medij za snimanje:	microSD
Video format:	AVI	Rezolucija kamere:	1280 (H) x 720 (V)				

**Odgovarajući
pribor:**

HD VIDEOSKOPSKA SONDA, 0°, Ø 3,9 MM

- 6 bijelih mini LED svjetiljki s prigušivačem
- radijus savijanja maks. 5 cm
- može se priključiti na HD videoskop 550.7501

1000 mm



Ø 3,9 mm



HD

550.7506

1493,00* HRK



*U cijene nije uračunat zakonom propisan porez na dodanu vrijednost.



S TELESKOPSKOM DRŠKOM



SLIKA SE PRENOSI DIREKTNO I ČUVA



VODONEPROPUSNO

6 bijelih mini LED svjetiljki s prigušivačem

1.120 MM

60°

uključujući kuk, magnet i ogledalo

Komforna Wifi konekcija sa direktan prenos na telefonu

HD

iOS Android Tablet

USB 2.0

IP67

STANDARD

WIFI VIDEOSKOP SET S PREDNJOM KAMEROM

BROJ ARTIKLA	550.7510	550.7540	550.7520
Trajanje rada:	oko 60 min	oko 60 min	oko 60 min
Rezolucija kamere:	1600 x 1200 (YUV), 1280 x 720 (fotografiranje) = 2,0 megapiksela	1600 x 1200 (YUV), 1280 x 720 (fotografiranje) = 2,0 megapiksela	1600 x 1200 (YUV), 1280 x 720 (fotografiranje) = 2,0 megapiksela
Aku materijal:	Litij ionski	Litij ionski	Litij ionski
Ø Glave:	5,5 mm	6,0 mm	3,9 mm
Kut kamere:	0°	0 + 90°	0°
uključujući kuk, magnet i ogledalo	✓	X	✓

7 -dijelni

Ø 5,5 MM

550.7510 **593,00*** HRK

4 -dijelni

DUAL

Ø 6,0 MM

550.7540 **743,00*** HRK

7 -dijelni

Ø 3,9 MM

550.7520 **1043,00*** HRK

150.4217

RADIONIČKI KALEM ZA NAMATANJE KABLA

- posebno jak, automatski mehanizam za vraćanje
- 180° slobodno zakretno
- Opterećenje u namotanom stanju: 1000 W
- Opterećenje u odmotanom stanju: 3000 W
- zidna pričvrtna šina 205 mm od metala

Dužina kabla: 15 metara

prikjučni kabel 1,0 m

NEMA UPLETENIH KABLA!

893,00* HRK

150.9205

SET MJERNIH POSUDA

- set praktičnih veličina mjernih posuda
- otporno na lomljenje
- postojano na ulje, benzin i kiseline
- s ručkom i slivnikom
- PE (polietilen)

skale: L / ml, kupovi, unce, četvrti



TRIVELIČINE, JEDNA CIJENA

57,00* HRK

150.9240

SET LIJEVAKA

- set praktičnih veličina lijevaka
- otporno na lomljenje
- postojano na ulje, benzin i kiseline
- vezica za držanje za komfornu uporabu
- HDPE (polietilen visokog tlaka)



72,00* HRK

*U cijene nije uračunat zakonom propisan porez na dodanu vrijednost.

VISOKE PERFORMANSE UZ NISKE CIJENE!

515.1315



THE MINIDEVIL UČINKOVIT PNEUMATSKI UDARNI ODVIJAČ

- lako rukovanje
- 3-struki izbor okretnog momenta
- Jumbo udarni mehanizam velike snage
- dug vijek trajanja
- izuzetno lagano kućište od aluminija



TEHNIČKI PODACI:

Maks. veličina vijka:	M 16
Potrošnja zraka:	169 l/min
Radni tlak:	6,3 bar (90 psi)
Min. promjer crijeva:	3/8" - 10 mm

593,00* HRK

515.1200



THE DEVIL UČINKOVIT PNEUMATSKI UDARNI ODVIJAČ

- lako rukovanje
- 3-struki izbor okretnog momenta
- udarni mehanizam s dva čekića visokih performansi
- dug vijek trajanja
- izuzetno lagano kućište od aluminija



TEHNIČKI PODACI:

Maks. veličina vijka:	M 16
Potrošnja zraka:	169 l/min
Radni tlak:	6,3 bar (90 psi)
Min. promjer crijeva:	3/8" - 10 mm

518,00* HRK

*U cijene nije uračunat zakonom propisan porez na dodanu vrijednost.

515.1270

MINIMONSTER UČINKOVIT PNEUMATSKI UDARNI ODVIJAČ

- lako rukovanje
- industrijski veliki udarni mehanizam visokih performansi
- dug vijek trajanja
- izuzetno lagano kućište



1390 Nm

1/2"



968,00* HRK

515.1210

MONSTER UČINKOVIT PNEUMATSKI UDARNI ODVIJAČ

- s praktičnom prebacivačkom polugom (lijevo / desno)
- lako rukovanje
- udarni mehanizam s dva čekića visokih performansi
- dug vijek trajanja



1690 Nm

1/2"

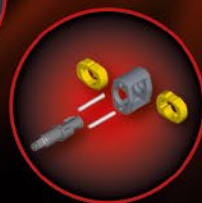

968,00* HRK

*U cijene nije uračunat zakonom propisan porez na dodanu vrijednost.

STANDARD

12V
SPECIAL

515.1150

MINIMONSTER XTREMELIGHT UČINKOVIT PNEUMATSKI UDARNI ODVIJAČ

- s praktičnom jednoručnom prebacivačkom polugom (lijevo / desno)
- industrijski veliki udarni mehanizam visokih performansi
- dug vijek trajanja
- izuzetno lagano kompozitno kućište

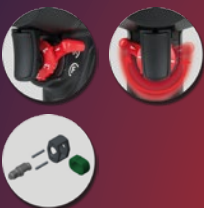

1390 Nm

~1 KG



Provjereni & preporučeni

AGR

BdR

Isprobano i preporučeno od strane foruma: Zdrava leđa - bolji život (Gesunder Rücken - besser leben e.V.) i Udruge njemačkih škola za prevenciju bolova u leđima (Bundesverband deutscher Rückenschulen (BdR) e.V.). Dodatne informacije: AGR e.V., Stader Str. 6, 27432 Bremen-Vörde, tel. 04761/92 63 580, www.agr-ev.de



1118,00* HRK

TEHNIČKI PODACI:

Maks. veličina vijka:	M 16
Potrošnja zraka:	135 l/min
Radni tlak:	max. 6,3 bar
Min. promjer crijeva:	3/8" - 10 mm

SUPERMONSTER PNEUMATSKI UDARNI ODVIJAČ VISOKIH PERFORMANSI

- s 4-strukim predizborom okretnog momenta za zatezanje i odvijanje
- lako rukovanje
- udarni mehanizam s dva čekića visokih performansi
- dug vijek trajanja



NAŠ PAKET SNAGE

3.405 Nm

>6,7 KG

TEHNIČKI PODACI:

Maks. veličina vijka:	M 38
Potrošnja zraka:	283 l/min
Radni tlak:	max. 6,3 bar (90 psi)
Min. promjer crijeva:	3/4" - 19 mm

Artikl		kg	
515.3250	3/4"	6,70	HRK 5618,00
515.3270	1"	6,75	HRK 5618,00
515.3260	3/4"	7,76	HRK 5993,00
515.3280	1"	7,82	HRK 5993,00

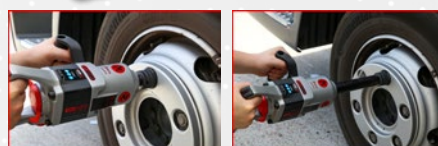

5618,00* HRK

AUTOMATSKI NAMATAČ ZA PNEUMATSKO CRIJEVO

- sa zidnim držačem
- za komprimirani zrak i vodu
- bubanj 180° slobodno okretan pomoću zidnog pričvršćivanja
- automatsko vraćanje
- plastično kućište otporno na udarce



NEMA VIŠE SAPLITANJA!

TEHNIČKI PODACI:

Priključni navoj:	3/8" - 10 mm
maks. tlak:	20,0 bar
Unutarnji promjer crijeva:	10,0 mm
Dužina crijeva:	15 + 1,5 m



TEHNIČKI PODACI:

Priključni navoj:	1/2" - 13 mm
maks. tlak:	20,0 bar
Unutarnji promjer crijeva:	13,0 mm
Dužina crijeva:	15 + 1,5 m



515.3440 743,00* HRK

515.3445 1193,00* HRK

*U cijene nije uračunat zakonom propisan porez na dodanu vrijednost.

Svijetlo za radionice

150.4435

PERFECTLIGHT 5 + 1 KONTROLNA SVJETILJKA 100 LUMENA

- idealno za radove neovisno o mreži
- učinkovit Spot LED
- iznimna učinkovitost COB Front LED
- 3 modus svjetla: 2 stepena svjetline i reflektor svjetlo
- zaštićeno od prskanja vode prema IP20



ZAŠTIĆENO OD PRSKANJA VODE



72,00* HRK

TEHNIČKI PODACI:

maks. trajanje svjetla:	3 sat
maks. svjetlosni fluks:	100 lumena
Radna temperatura:	-10° / +40°C

150.4370

PERFECTLIGHT DŽEPNA SVJETILJKA 85 LUMENA

- Idealno za džepove pregača i košulja
- 25 m dometa svjetlosti
- oko 5 - 10 sati rada žarulje
- s 2 x AA 1,5 V baterije
- ultra lagano aluminijsko kućište otporno na udarce



113,00* HRK

TEHNIČKI PODACI:

maks. trajanje svjetla:	10 sat
maks. svjetlosni fluks:	85 lumena
Radna temperatura:	-10° / +45°C

150.4495

MOBILNA COB LED RADIONIČKA RUČNA SVJETILJKA, PREKLOPNA

- idealno za radove neovisno o mreži
- 3 Watt COB LED + 1 x LED svjetiljka za glavu
- tijelo kućišta presvučeno kvalitetnom gumom
- zaštićeno od prskanja vode prema IP20
- otporno na udarce

180° PREKLOPIV, MAGNETNI STALAK



153 mm

TEHNIČKI PODACI:

maks. trajanje svjetla:	3,5 sat
Snaga svjetlosti:	150 / 60 lumena
Radna temperatura:	-17° / +55°



72,00* HRK

*U cijene nije uračunat zakonom propisan porez na dodanu vrijednost.

STANDARD

SPECIAL



PARALELNA STEGA

- s okretnim tanjurom
- apsolutno paralelno zatezanje pomoću podesivog cenriranog vođenja
- zatezne čeljusti oblikovane posebno visoko čime su moguće zatezne dubine
- veliki nakovanj za radove ispravljanja i držanje
- čeljust i nakovanj induktivno ojačani



Artikl	Zatezno područje mm	Dužina čeljusti	HRK
914.0004	120,0	4"	968,00
914.0005	140,0	5"	1043,00
914.0006	170,0	6"	1118,00
914.0008	200,0	8"	1343,00

VELIKA ZATEZNA OBLAST

od **968,00*** HRK

150.9239

POSUDA ZA VODU

- višestruke mogućnosti primjene
- otporno na lomljenje
- s 2 ručke za nošenje
- slivnik omogućava čisto pražnjenje
- odgovara za vodu i rashladne tekućine



9L



132,00* HRK



RASPRŠIVAČ S POTISNOM CRPKOM

- od kvalitetnog polietilena
- za različite kemikalije kao npr. sredstvo za čišćenje kočnica, sredstva za pranje, rastvaranje i čišćenje itd.
- glava raspršivača od mesinga, može se podešavati i zatvarati
- brtve od vitona
- odgovara za radove iznad visine glave

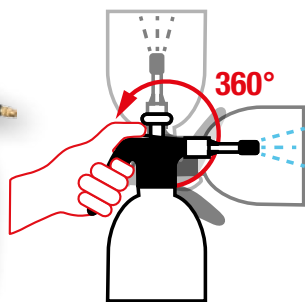

Artikl	zapremina u litrama	HRK
150.8251	1	64,00
150.8252	2	72,00

od **64,00*** HRK

800.0960

ALUMINIJSKA SIGURNOSNA PLATFORMA

- sa protukliznim profilom na pokretnoj platformi
- sa velikom platformom za sigurnu stabilnost
- sa sigurnosnim zaključavanjima
- preklopiva te se stoga mogu skladištiti uz uštedu prostora
- plastični rubovi na stopama štite pokretnu platformu i pod



SUPER SIGURNO SUPER PRAKTIČNO

563,00* HRK

500.8100

UNIVERZALNA TELESKOPSKA VIŠENAMJENSKA KOLICA S KOTAČIMA

- idealno za popravke karoserija, u području lakiranja ili za vjetrobranska stakla
- multitalent - univerzalna primjena zahvaljujući podesivosti visine i širine
- poslije korištenja mogu se sklopiti te ne zauzimaju mnogo mjesta
- prihvatni s neklizajućim gumenim slojem za izbjegavanje ogrebotina
- opteretivost do 100 kg

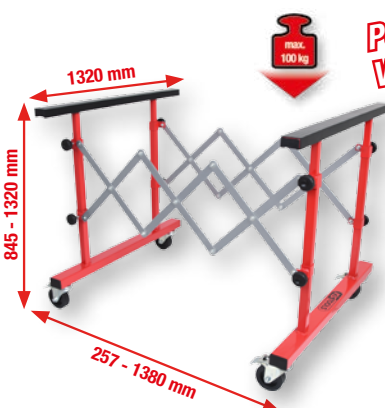

PODESIVO PO VISINI I ŠIRINI

1118,00* HRK

500.8030

POKRETNA STOLICA PODESIVA PO VISINI

- izdržljiva i pokretna stolica
- sa razinom za spremanje alata i sitnih dijelova
- periva punjena navlaka
- hidrauličko podešavanje visine
- maksimalna opteretivost do 90 kg



443,00* HRK

*U cijene nije uračunat zakonom propisan porez na dodanu vrijednost.

500.8002

ZAŠTITNA PROSTIRKA S RUČKOM ZA NOŠENJE

- jamči zdravstveno svjestan rad na ravnoj površini
- odbija vlagu i prljavštinu
- radna odjeća i koljena ostaju suhi, čisti i ne hlade se
- otporno na benzin i ulje



IZUZETNO UDOBNO



263,00* HRK

ZAŠTITNA PROSTIRKA

- jamči zdravstveno svjestan rad na ravnoj površini
- odbija vlagu i prljavštinu
- radna odjeća i koljena ostaju suhi, čisti i ne hlade se
- otporno na benzin i ulje



500.8040



500.8045

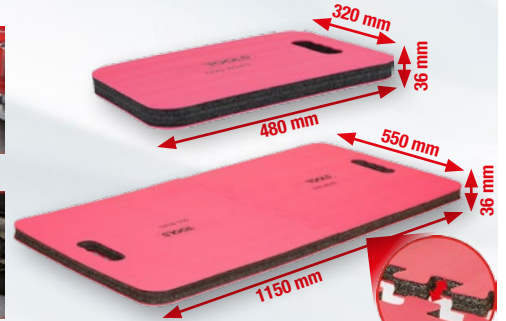

Artikl	Dužina mm	Širina mm	HRK
500.8040	480,0	320,0	72,00
500.8045	1150,0	550,0	263,00

od **72,00*** HRK

500.8011

POKRETNJA LEŽALJKA I SKLOPIVO SJEDIŠTE

- za primjenu u ležećem i sjedećem položaju
- sa sigurnosnim zaključavanjem za rad bez napora
- obložena varijanta za rad bez zamaranja
- periva punjena navlaka
- mala visina za udoban rad



UVIJEK USPIJEVA

368,00* HRK

500.8090

POKRETNJA LEŽALJKA

- s oblikovanim područjima za ruke za optimalnu slobodu kretanja
- s bočnim dijelovima za spremanje alata
- lako za čišćenje
- maksimalna opterećenost do 120 kg

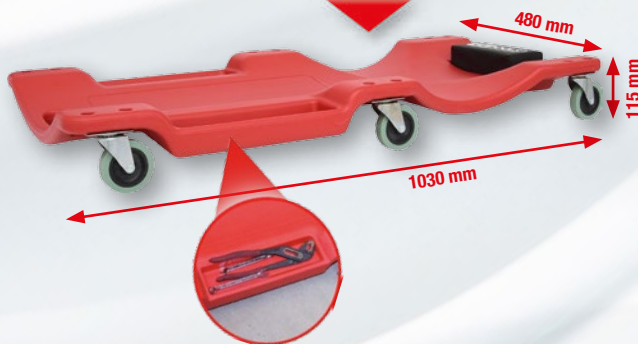

518,00* HRK

160.0342

TELESKOPSKI PODLOŽNI POTPORNIK

- idealno za sve radove pri kojima je potrebno dodatno podupiranje
- stabilno trapezno navojno vreteno
- laka aktivacija preko aksijalnog ležaja
- nožna pedala za fino podešavanje (20mm)
- idealan pomoćnik u radionici u brojnim situacijama



POUZDANO ČEVAS PODRŽATI

743,00* HRK

*U cijene nije uračunat zakonom propisan porez na dodanu vrijednost.

865.0201

XXL RADNI STOL S 3 LADICE I 1 VRATIMA

- visoka stabilnost
- visoka stabilnost zahvaljujući zavarivanju svih čeličnih dijelova
- vrata koja se mogu zatvoriti
- centralno zaključavanje svih ladicica pomoću cilindrične brave
- ladicice s neklizajućim gumenim uloškom



XXL

Velika klupa za velike zadatke

7493,00* HRK



140.3050

IGLIČASTE TURPIJE-SET S PLASTIČNIM NOSAČEM U FUTROLI

- visok broj udara
- s plastičnom mapom
- za radove u području precizne mehanike
- specijalni čelik za alate



12
-dijelni

- ▯ 5,0 x 1,0 mm
- ▯ 5,0 x 1,0 mm
- 3,0 mm
- 3,0 mm
- 5,0 mm
- 5,0 mm
- △ 3,0 mm
- △ 2,0 mm
- △ 2,0 mm
- △ 5,0 mm
- △ 5,0 mm
- 5,0 mm



145 mm

57,00* HRK

140.3000

RADIONIČKE TURPIJE-SET

- DIN 7261 oblik B, C, D, E, F
- udubljenje 2
- 200 mm dužina
- s 2-komponentnom ručkom
- specijalni čelik za alate



5
-dijelni

Sadrži po jednu ravnu, polukružnu, okruglu, četverokutnu i trokutnu turpiju dužine 200 mm i s udubljenjem 2.

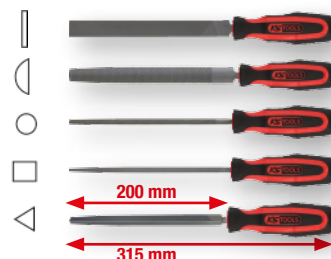

188,00* HRK

907.2105

PREKLOPNI NOŽ S BLOKADOM

- oštrica premazano slojem teflona
- fiksiranje oštrice rasklopivo
- neklizajuća drška s udubljenjima za prste
- idealno za mehaničare

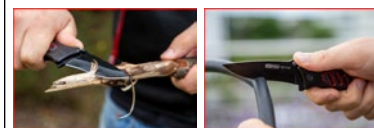

64,00* HRK

907.2225

PREKLOPNI NOŽ S BLOKADOM

- obložena oštrica
- fiksiranje oštrice rasklopivo
- lagano i lako za rukovanje
- ručka od eloksanog aluminija
- sa stezaljkom za remen

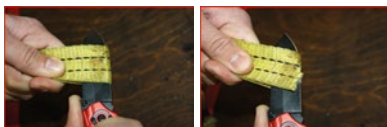

72,00* HRK

907.2220

PREKLOPNI NOŽ SA ZAPORNIKOM I REZAČEM POJASEVA

- obložena oštrica
- fiksiranje oštrice rasklopivo
- integriran rezač pojaseva na ručki
- lomilica stakla na kraju ručke
- lagano i lako za rukovanje



72,00* HRK

*U cijene nije uračunat zakonom propisan porez na dodanu vrijednost.

907.2240

SKIDAČ NALJEPNICA

- idealno za skidanje plaketa, ostataka brtvi i ljepljiva
- s lako zamjenjivom i upusnom oštricom
- s pričrpsnom rupom
- Oštrica strugača radi zaštite upusna u dršku preko kliznog dijela
- s metalnim kućištem

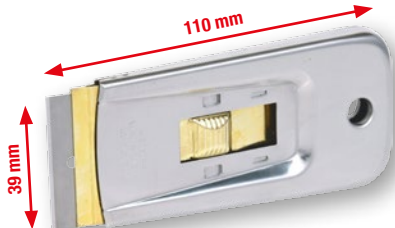

5 KOMADA

S1 OŠTRICOM

38,00* HRK

Pribor:
911.8127 Rezervne oštrice strugača HRK 23,00

907.2200

NOŽ-STRUGAČ-SET

- idealno za skidanje plaketa, ostataka brtvi i ljepljiva
- jednostavna zamjena oštrice odvijanjem vijka na zateznoj glavi
- praktičan sustav čuvanja pomoću zamjenjivih oblika oštrice
- odgovara za različita područja primjene zahvaljujući različitim oštricama
- profesionalan univerzalni nož s aluminijskim kućištem



27
-dijelni



12 - 16 - 20 mm

188,00* HRK

162.0370

GURAČ RASCJEPKI-SET

- radni krajevi ojačani
- vrh se može brusiti
- osovina zlatne boje, lakirana
- krom-molibden
- u prijklopnom sanduku od lima



6
-dijelni



- Ø 10 x 3 -
- Ø 10 x 4 -
- Ø 10 x 5 -
- Ø 10 x 6 -
- Ø 12 x 8 -
- Ø 12 x 10 mm

188,00* HRK

MIKRO FINO PLETENE RUKAVICE - CRNE

- vrlo udoban oblik
- posebna propusnost zraka
- s PU-slojem s unutarnje strane
- vrlo pogodno za rad s malim dijelovima
- s logotipom



Artikli

310.0470	9	HRK 143,00
310.0475	10	HRK 143,00
310.0480	11	HRK 143,00

12 PARI
od

143,00* HRK

KOŽNE RUKAVICE ZA MEHANIČARE

- dobar osjećaj prilikom nošenja za radove s malim dijelovima
- unutarnja površina od sintetičke kože
- s podlogama koje prigušuju vibracije
- s elastičnom trakom na ručnom zglobu
- s čičak zatvaračem



Artikli

310.0250	9	HRK 132,00
310.0255	10	HRK 143,00
310.0260	11	HRK 143,00

od
132,00* HRK

310.0195

ZAŠTITNI ŠLJEM ZA ZAVARIVAČE

- automatski se prebacuje sa svijetlog na tamno, čim se upali svjetlosni luk
- zahvaljujući kvalitetnim solarnim stanicama promjena baterija nije potrebna
- opremljeno s prekidačem za osjetljivost i kašnjenje za prebacivanje s tamnog na svijetlo, kako bi se izbjegli loši varovi kada se radi s jakom strujom
- moguće brzo prebacivanje za kontinuirano i točkasto zavarivanje
- potpuna zaštita vrata



518,00* HRK

310.0110

ZAŠTITNE NAOČALE - PROZIRNE

- pogodno za osobe koje nose naočale
- s ventilacijskim rupama za pogled bez magljenja
- čvrst okvir
- s lukovima za uši
- ploča od polikarbonata



23,00* HRK

*U cijene nije uračunat zakonom propisan porez na dodanu vrijednost.

STANDARD

SPECIAL

150.1628

ALAT ZA SKIDANJE DRŠKE VRATA ZA VAG

- sa specijalnim profilom
- za odvijanje teško pristupačnih kuka za zaključavanje u slučajevima ručki vrata bez cilindra
- potrebno za demontažu ručke vrata
- s 2-komponentnom ručkom
- krom vanadij

područja primjene: Volkswagen Arteon >2017, Caddy >2016, Golf Sportsvan >2015, Passat >2015, Tiguan >2016, Touran >2016 i Audi Q2 >2016

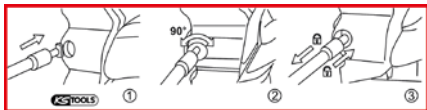

113,00* HRK



911.8181

MONTAŽNA KLIJEŠTA, PRAVA

- za demontažu plastičnih raširnih zakovica, udarnih zakovica i stezaljki
- uklanja iglu i sidro bez oštećenja
- savijeni vrhovi
- samootvarajuće
- s izoliranom ručkom



218,00* HRK



911.8182

MONTAŽNA KLIJEŠTA, POVIJENA

- za demontažu plastičnih raširnih zakovica, udarnih zakovica i stezaljki
- uklanja iglu i sidro bez oštećenja
- savijeni vrhovi
- samootvarajuće
- s izoliranom ručkom



218,00* HRK



150.1010

AKU SET ZA POPRAVKU

- odgovara za popravku pukotina ili sličnih oštećenja na plastičnim dijelovima (od 1 mm debljine)
- odgovara i za plastiku s udjelom staklenih vlakana od maks. 40%
- pogoni se preko punjive baterije, rad nezavisan od mreže
- prihvat za grijnu šipku za različite stezaljke za popravke s Ø 0,6 i 0,8 mm

Područja primjene: branici, poklopci, tapacirunzi itd.

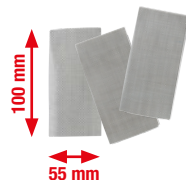
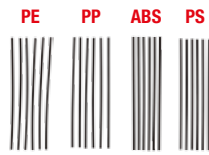
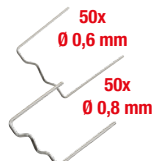

TEHNIČKI PODACI:

Trajanje rada:	oko 90 min
Radna temperatura:	0°C do +500°C
Vrijeme punjenja:	3-4 sata
Snaga:	30 Watt



134 -dijelni



1118,00* HRK

115.5050

KLIJEŠTA ZA SKIDANJE STEZALJKI CRIJEVA-SET

- za jednostavno odvajanje fleksibilnih crijevnih vodova od 15,9 mm (5/8") do 60,0 mm (2.3/8")
- crijevo se širokom površinom priklješti na stabilnu površinu, na taj način se izbjegava oštećenje crijeva
- štiti prilikom radova održavanja od prodiranja benzina, ulja, vode i antifrizza za hladnjak
- idealno primjenjivo za putnička vozila, transportere, velike limuzine, komercijalna vozila, traktore, poljoprivredne i građevinske strojeve i za potrebe u industriji
- postojano na temperaturu do 160 °C

3 -dijelni

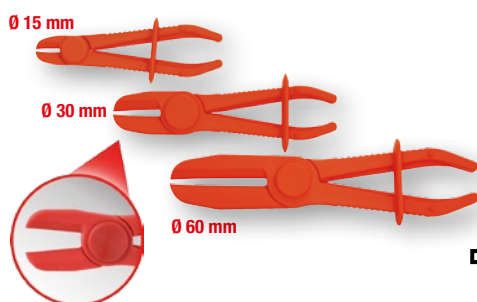

143,00* HRK



550.1285

REFRAKTOMETAR - OPTIČKI KONTROLNI UREĐAJ ZA TEKUĆINU U AKUMULATORU, SREDSTVO ZA ZAŠTITU OD MRAZA I ADBLUE®-ADITIVI

- za brzu i preciznu kontrolu sadržaja kiseline u tekućini baterija, sadržaja antifrizza i AdBlue® aditiva
- primjenjivo i za vodu za hlađenje i stakla
- primjenjivo i na temperaturama ispod 10°C
- kvalitetna varijanta od aluminija

*AdBlue® je registrirana marka VDA udruženja automobilske industrije e.V.



DOBAR PREGLED!



638,00* HRK



*U cijene nije uračunat zakonom propisan porez na dodanu vrijednost.

515.1980

PNEUMATSKI PIŠTOLJ ZA ČIŠĆENJE

- idealno za profesionalno čišćenje tapacirunga, stranica vrata, ventilacijskih kanala, tepiha, prostirki, sjedišta od platna itd.
- jedinstvena, ciklonska, kuglično smještena rotaciona tehnologija čišćenja
- za sve moguće površine, vlažno ili suho čišćenje
- i za teško dostupna mjesta, npr. između sjedišta i šavova
- zahvaljujući fino raspršenom rastvoru za čišćenje očišćene površine suše se posebno brzo



**ZA SVE
POVRŠINE**

1.000 ML



1/4"PT



TEHNIČKI PODACI:

Radni tlak:	max. 6,3 bar (90 psi)
Min. promjer crijeva:	3/8" - 10 mm

938,00* HRK

515.1935

SET PIŠTOLJA ZA ČIŠĆENJE KOMPRESIRANIM ZRAKOM S USISNIM UREĐAJEM

- idealno za profesionalno čišćenje tapacirunga, stranica vrata, ventilacijskih kanala, tepiha, prostirki, sjedišta od platna itd.
- pogon komprimiranim zrakom s jednostavnim rukovanjem
- jedinstvena, ciklonska, kuglično smještena rotaciona tehnologija čišćenja
- za sve moguće površine, vlažno ili suho čišćenje
- s 360° okretnom i 30° nagibnom utičnom prskalicom kuglastog zgloba



1.000 ML

**ZA SVE
POVRŠINE**



1/4"PT

1,8 m

Ø32 - 42 mm



3
-dijelni

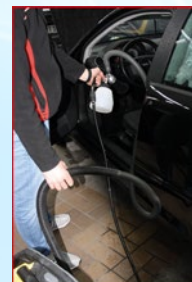

TEHNIČKI PODACI:

Radni tlak:	max. 6,3 bar (90 psi)
Potrošnja zraka:	120 l/min
Min. promjer crijeva:	3/8" - 10 mm

1193,00* HRK

150.9565

NASTAVAK ZA MASKIRNE ZAKOVICE

- Nastavak za maskirne zakovice za bušilice, odvijače ili aku odvijače s desnim ili lijevim hodom
- za primjenu je potreban okretni moment od 11 Nm i broj okretaja od maks. 1000 o/min
- velika ušteda vremena i troškova
- jednostavno rukovanje
- od ugljenoga čelika s plastičnim kućištem

Maskirne zakovice od aluminija:
2,4 - 3,2 - 4,0 - 4,8 mm
Maskirne zakovice od čelika:
2,4 - 3,2 - 4,0 mm



1/4"

Ø 58 mm

58 mm

143,00* HRK



150.3010

UREĐAJ ZA MJERENJE DEBLJINE SLOJA BOJE

- za brzo mjerenje premaza
- za premazivanje aluminija, metala i nemetala
- idealno za pokrivanje šteta od nezgoda
- digitalni prikaz s osvjetljenjem
- jednoručno rukovanje



TEHNIČKI PODACI:

Indikator:	3.1/2" LCD-indikator
mjerni okvir "debljina":	0-40 mils (0-1000 µm)
okruženje rukovanja:	0°C - 50°C (32°F - 50°F) < 75% vlažnost zraka

1163,00* HRK

*U cijene nije uračunat zakonom propisan porez na dodanu vrijednost.

150.1930

MASTER RASHLADNI SUSTAVI-DIJAGNOSTIKA-SERVIS-SET

- idealan sastav za provjeru tlaka sustava za hlađenje, te kapa za zatvaranje
- brzo pronalaženje nezabrtvljenih mjesta u rashladnom sustavu, npr. brtve glave cilindra, agregata hladnjaka, crpki za vodu, crijeva itd.
- odgovara za skoro sva uobičajena vozila s vodom hlađenim motorima, npr. Europa, Japan, SAD itd.
- brza i učinkovita primjena



2018,00* HRK

150.9388

3-KRAKI UNIVERZALNI KLJUČ ZA SENZOR I PUMPU GORIVA

- idealno za odvijanje i zatezanje plastičnog prstena za zatvaranje davača rezervoara na rezervoaru za gorivo
- omogućuje jednostavan rad uz uštedu vremena
- bez oštećenja prstena alatom
- dozvoljava radove u tijesnim međuprostorima
- neznatna prostorna potreba



518,00* HRK

550.1136

FLEKSIBILNO KONTROLNO OGLEDALO S OSVJETLJENJEM

- idealno za radove neovisno o mreži
- LED žarulja
- za optičku kontrolu i traženje greške
- s dvostrukim kuglastim zglobom
- oko 60 sati rada žarulje



72,00* HRK

150.3610

ALAT ZA VAĐENJE SIGURNOSNOG PRSTENA-SET

- za demontažu sigurnosnog prstena i malih šolja ležaja
- odgovara i za teško pristupačna mjesta
- brza i laka demontaža
- pomoću udarnih tegova udara se vrh navoja u sigurnosnom prstenu i rukom zavrće, a udarnim tegom izvlači
- dug vijek trajanja zahvaljujući ojačanoj poluzi



**GOSPODAR
SIGURNOSNIH
PRSTENA**



2
-dijelni

263,00* HRK

*U cijene nije uračunat zakonom propisan porez na dodanu vrijednost.

700.1280

UNIVERZALNI MONTAŽNI ALAT ZA BRTVENI PRSTEN OSOVINE I ZAŠTITNI PRSTEN-SET

- za profesionalnu montažu i demontažu sigurnosnih prstena i brtvi osovine bez oštećenja
- za preciznu primjenu na osovinama motora, kao što su koljenasta, bregasta ili pomoćna osovina
- univerzalno primjenjivo za radijalne brtvene prstene promjera 21,5 do 64,0 mm
- velika ušteda troškova i vremena

Područja primjene: obiman univerzalan alat za prešanje radijalnih brtvenih prstena u promjere od 21,5 do 64,0 mm na skoro svim vozilima

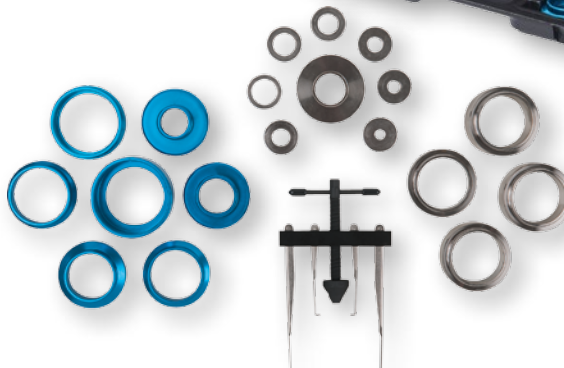
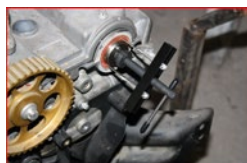

24
-dijelni



1118,00* HRK

913.1415

SET ODVIJAČA ZA SPECIJALNE MATICE

- za odvijanje i vadenje zapekljenih klinova kotača s oštećenim „okruglim“ glavama
- specijalan lijevi urezni navoj s 6 konusnim oštricama
- posebno plosnata i kompaktna varijanta
- pogon se može vršiti po izboru preko nasadnog ili okastog ključa



NAŠ ALAT ZA RJEŠAVANJE PROBLEMA



Za do 80% zaobljene vijke!

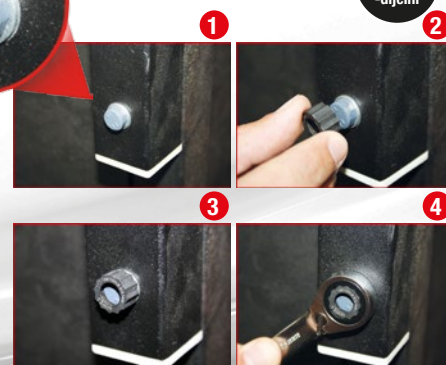

12
-dijelni

143,00* HRK

150.1910

CO2-TEST CURENJA GLAVE CILINDRA-SET

- za lokalizaciju nezabrtvljenih mjesta na motorima s unutarnjim sagorijevanjem
- racionalno i pouzdano pronalaženje pukotina i mjesta curenja
- dokazuje se eventualan CO2 sadržaj u tekućini hladnjaka
- idealno primjenjivo za glave cilindra, brtve glava cilindra i blokove motora
- za sva uobičajena vozila s vodom hlađenim motorima (gas, dizel i benzin)

SREĆA BEZ PRAZNINA

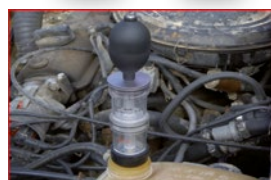

8
-dijelni

968,00* HRK

*U cijene nije uračunat zakonom propisan porez na dodanu vrijednost.

STANDARD

12V SPECIAL

911.1740

KLJUČ ZA PROTUDRŽANJE REMENICE ZA MERCEDES

- specijalan profil omogućuje protudržanje prilikom odvijanja ili zatezanja centralnog vijka koljenastog vratila
- kratka poluga
- ugljični čelik

Područja primjene: Mercedes (šifra motora: M271)



150.2233

SPECIJALAN ALAT ZA ODVIJANJE HENN® OBUJMICA

- univerzalna primjena za vozila s HENN® obujmicama
- idealno za otključavanje i odvijanje stezaljki na crijevima za punjenje zraka ili sredstva za hlađenje
- glava podesiva za 90° pomoću ručke za teško pristupačna mjesta
- s izoliranom ručkom



405.0155

SET SPECIJALNIH KLJUČEVA ZA PROVOĐNIK INJEKTORA

- 6-kutni
- specijalna dužina i model
- Pogon i kočenje se nalaze na osovini i omogućavaju tako kontrolirano zatezanje navoja
- otvor omogućuje okretanje za 180°



4
-dijelni

Područja primjene: BMW, Kia, Hyundai i Mercedes



405.0070

SET IZVLAKAČA MLAZNICA ZA UBRIZGAVANJE ZA FORD

- idealno za demontažu mlaznica za ubrizgavanje na Ford EcoBoost GDI motorima
- omogućuje kratke i intenzivne udarce zahvaljujući udarnoj težini
- izdržljiva varijanta
- glava cilindra ne služi za protuležaj



3
-dijelni

Područja primjene: Ford EcoBoost GDI 1,0 L do 2,0 L



400.9075

SKIDAČ KOTAČA CRPKI VISOKOG TLAKA ZA VAG

- idealan za skidanje kotača crpki visokog tlaka s vratila
- 15 mm pritisni vijak s šesterokutnom glavom i 24 mm šesterokut za držanje
- za ručni pogon
- izdržljiva varijanta



Područja primjene: Volkswagen Golf >2013, Audi A3 >2013, Škoda Rapid >2012, Octavia, >2013, Fabia 2014, Superb >2015, Kodiaq 2016, Seat Alhambra >2011, Ibiza 2008, Leon 2013 i Ateca s 1.4, 1.6 i 2.0 litarskim TDI motorima



500.7505

SKIDAČ KALEMA ZA PALJENJE ZA ŠTAPNE KALEME ZA PALJENJE

- idealno za brzu i sigurnu demontažu navoja paljenja
- sprječava oštećenja na namotaju i na kućištu
- fosfatiziran
- krom vanadij



Područja primjene: 1,2 l / 1,4 FSI + 2,0 l TFSI Volkswagen Golf (>2013), Audi A3 (>2013), Seat Leon (>2013), Škoda Octavia (>2013)



150.3305

ALAT ZA KLINASTO-REBRASTI REMEN

- odgovara za montažu i demontažu elastičnog klinastog rebrastog remena
- brža i profesionalna zamjena remena bez problema
- bez oštećenja remenice i remena
- potrebna minimalna snaga
- specijalni čelik za alate



*U cijene nije uračunat zakonom propisan porez na dodanu vrijednost.

911.3999



SPECIJALNI NASADNI KLJUČ ZA SVJEĆICE ZA BMW, SA ZGLOBOM

- dvostruki šesterokutni profil omogućuje prihvat šesterokutnih i dvanaesterokutnih svjećica
- sa zglobnom glavom za teško pristupačne svjećice
- guma olakšava montažu i demontažu
- bez oštećenja keramike

Područja primjene: BMW 1ica (E81 / E87), 3ka (E90) i 5ica (E60) s N43 motorima jer su svjećice ugrađene pod kutom >5°



113,00* HRK

500.7325



SET SPECIJALNIH NASADNIH KLJUČEVA S ZGLOBOM ZA SVJEĆICE I GRIJAČE

- 6-ivični i 12-ivični
- Dvostruki šesterokutni profil (14 mm nasadni ključ za svjećice) omogućava prihvat šesterokutnih i dvanaesterokutnih svjećica
- iznimno uska varijanta
- s zglobnom glavom za teško pristupačne svjećice i grijače
- s gumom za držanje svjećica i grijača



8 mm 9 mm 10 mm 12 mm 14 mm 16 mm

1/4"

3/8"

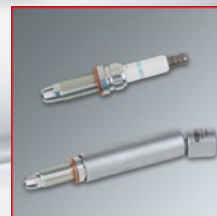

593,00* HRK

11
-dijelni

400.0060

SET ALATA ZA NAMJEŠTANJE REMENICA

- idealan za provjeru i namještanje remenica klinasto-rebrastih remenova prije montaže novog remena
- smanjuje habanje na remenu i remenici
- ručno podesiva šipka za namještanje od čelika
- glavno kućište s magnetom

Područja primjene: pogrešno namještene remenice, neispravne skretnice ili pumpe za vodu, klima kompresori i slobodan hod generatora

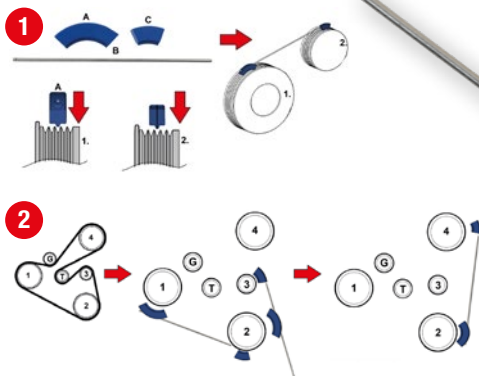
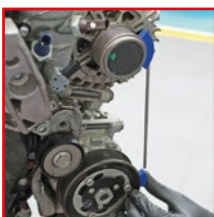

Jednostavno genijalno



3
-dijelni

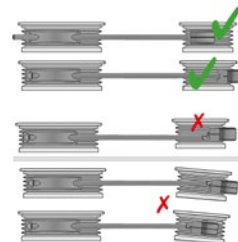

368,00* HRK

150.3170



UNIVERZALNI SKIDAČ REMENICE 2-KRAKI

- za užlijebjene remenice
- kraci skidača sa zaključavanjem
- zatezni luk snažno pritiska kuku
- sprječava isklizavanje
- neznatna potreba prostora uslijed kompaktne građe

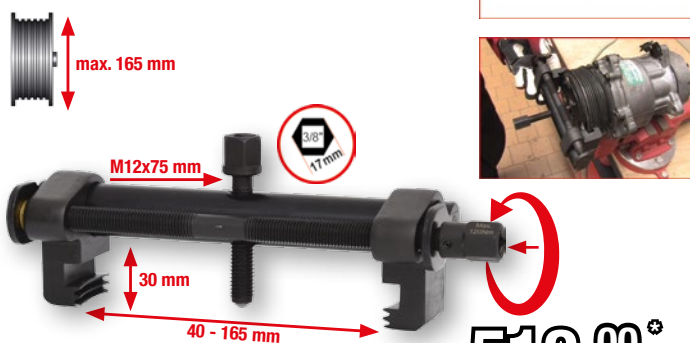

518,00* HRK

104.5050



CJEVASTI REZAČ S USTAVLJAČKIM TOČKOM

- za brzo i jednostavno odsijecanje cijevi s 2 potporna valjka i ustavljačkim mehanizmom s 3 priključka
- vrlo dobro vođenje uslijed široke površine nalijeganja jamči kutni rez
- dubina reza maks. 3 mm
- izdržljiv ustavljački mehanizam



ZA BOLJE REZANJE!



975,00* HRK

*U cijene nije uračunat zakonom propisan porez na dodanu vrijednost.

550.1173

LED COB STRIPE KONTROLNA SVJETILJKA 190 LUMENA S UV SPOT LED

- idealno za radove neovisno o mreži
- iznimna učinkovitost COB Front LED
- UV Spot LED velike jačine
- 2 modusa svjetla: 1 stupanj svjetline i UV spot svjetlo
- 2 jačine svjetla: COB Front 190 lumena i Spotlicht 60 lumena svjetlosnog fluksa



94,00* HRK

150.3075

12-42V DETEKTOR ZA LOKALIZACIJU KRATKOG SPOJA, PRIJELOMA KABELA I LUTAJUĆE STRUJE

- za brzo, jednostavno i profesionalno traženje kratkih spojeva, grešaka u kabelima i lutajuće struje bez potrebe probadanja vodova
- velika ušteda vremena zato što skidanje tapacirunga, tepiha i letvi na vozilu može se svesti na minimum
- za lokalizaciju električnih komponenti u vozilu
- za testiranje i pronalaženje povremenih prekida spojeva ("labavi kontakti")
- odašiljač je spojen sa strujnim kolom koje se ispituje s izoliranim krokodil stezaljkama preko kutije s osiguračima



2-dijelni



HAPPY END UMJESTO KRATKOG SPOJA



443,00* HRK

550.1649

12 V / 24 V DIGITALNI TESTER ZA SUSTAVE BATERIJA I PUNJAČA SA INTEGRIRANIM PISAČEM

- odgovara za baterije 12 V (baterije sa olovnom kiselinom, gelom, mokrim stanicama, kalcijem, MF, VRLA i AGM baterije i baterije sa dubokim ciklusom)
- za brzo i jednostavno utvrđivanje učinkovitosti baterije uz uzimanje u obzir kompenzacije temperature
- provjerava stanje baterija, unutarnji otpor, vrijednost struje pri hladnom startu
- sa funkcijom provjere starter baterije, startera i mjerenja ciklusa punjenja
- izbjegava se preopterećenje baterije suviše dugim trajanjem mjerenja



S PISAČEM



SA 3 ROLE PAPIRA ZA TISAK

ZA SKORO SVE BATERIJE

2243,00* HRK

TEHNIČKI PODACI:

Indikator:	digitalno
Radno područje CA / MCA:	40-2.000 CCA
Radno područje CCA:	40-2.000 CCA
Radno područje DIN:	40-2.000 CCA
Radno područje EN:	40-2.000 CCA
Radno područje IEC:	40-2.000 CCA
Radno područje JIS#:	40-2.000 CCA
Radno područje SAE:	40-2.000 CCA
Radna temperatura:	0°C do +55°C
Područje frekvencije:	100
Mjerno područje:	9-36 V
Preciznost mjerenja:	+/- 0,5 Megaohm
Područje napona:	9-36 V

*U cijene nije uračunat zakonom propisan porez na dodanu vrijednost.

150.1025

SET VOĐICA ZA KABELA

- sprječava oštećenja na izolaciji kabela
- pomaže korisniku prilikom uvlačenja ili izvlačenja kabela ili sondi u slučaju prepreka ili dijelova s oštrim rubovima
- nudi različite adaptivne mogućnosti pomoću različitih promjera i duljina
- zaokruženi otvor na kraju drške omogućava laku manipulaciju kablom ili sondama bez oštećenja
- s 4 različita nastavaka



5
-dijelni

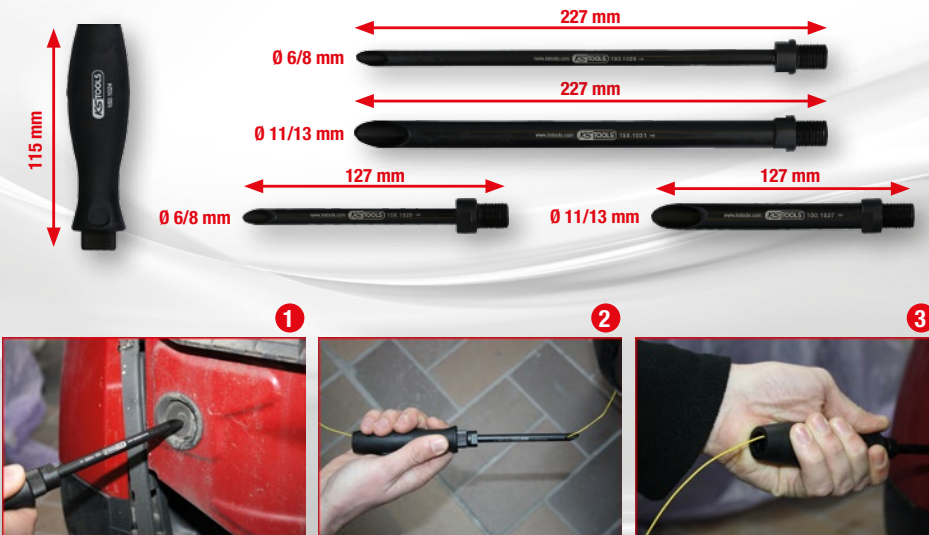

368,00*
HRK

150.0939

POMOĆNI ALAT ZA UVLAČENJE KABELA

- idealno za uvlačenje ili postavljanje kabela ili vodova
- zahvaljujući zaobljenoj glavi na kraju (Ø 5 mm), pomoćni dio za uvlačenje može se lako provući kroz cijev
- s omčom za pričvršćivanje kabela ili vodova
- oblik ostaje održan i može se u svakom trenutku promijeniti
- slobodno oblikovanje, stoga odgovara i za vrlo tijesne prostore

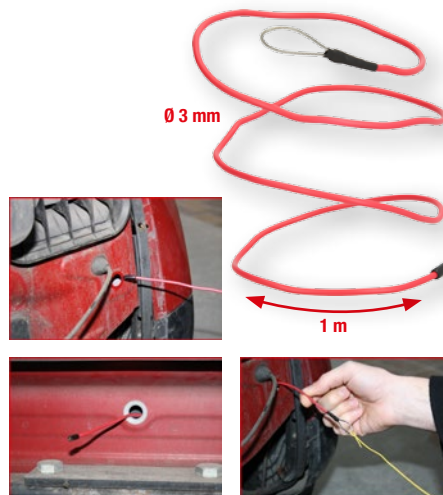

72,00*
HRK

117.1890

SET ALATA S IZOLIRANIM ALATIMA ZA HIBRIDNA I ELEKTRIČNA VOZILA

- izolacija prema IEC 60900
- u aluminijskom koferu
- specijalni čelik za alate



43
-dijelni

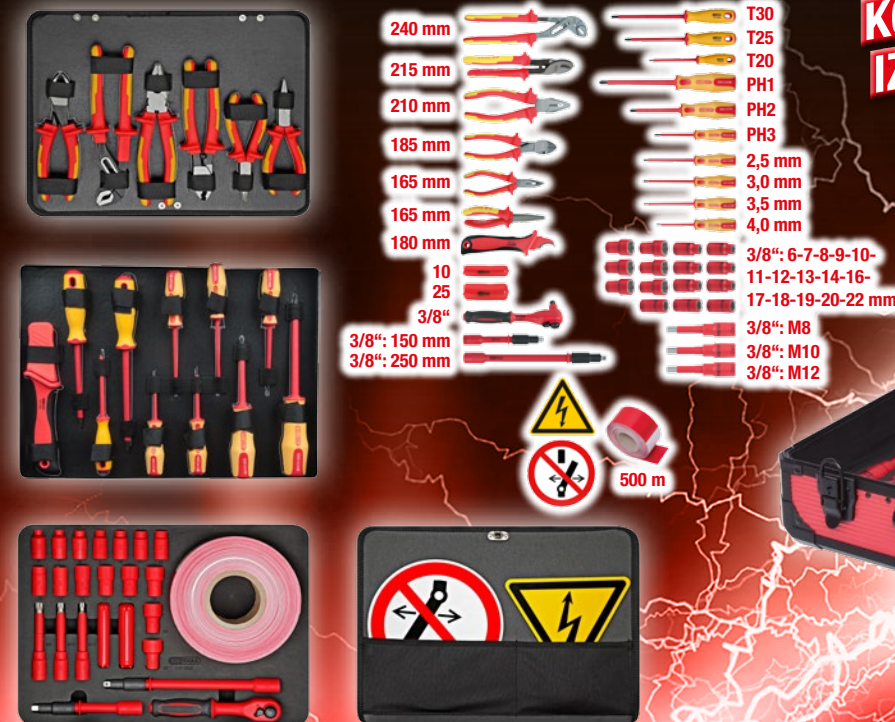

KOFER PUN
IZNENAĐENJA



3743,00*
HRK

*U cijene nije uračunat zakonom propisan porez na dodanu vrijednost.

150.9275

UNIVERZALNI SUSTAV ZA PUNJENJE ULJA U PRIJENOSNIK SA 20-DIJELNIM SETOM PRILAGODNIKA

- idealno za punjenje uljem prijenosnika, prijenosnika razdjelnika i diferencijala različitih proizvođača vozila
- veliki broj prijenosnika ne može se napuniti bez ovog alata
- optimalno za tijesne prostorne uvjete ili teško pristupačna mjesta
- za teško pristupačna područja



Ford 1/8" - 27 NPT

Universal

VAG

VAG, BMW + Mini M10 x 1,0

Mercedes 722,9, M12 x 1,5

VAG DSG M24 x 1,5

VAG + Porsche

Universal, 300 mm

VAG CVT M22 x 1,5

Škoda M18 x 1,5

VAG + Škoda M30 x 1,5

Volvo 5/16" - 24 UNF

Toyota + Lexus M18 x 1,5

Nissan + Infinity M8 x 1,0

ATF-VW Passat + Tiguan

Nissan Juke M12 x 1,25

Mini Cooper M14 x 1,5

Nissan M10 x 1,5

GM M12 x 1,75

Mercedes 725-9G



21
-dijelni

1643,00* HRK

500.8805

OPRUŽNI ZATEZAČ ZA MJERENJA KOMPRIMIRANOG ZRAKA S PRILAGODNIK-PLOČOM

- idealno za zatezanje opruga
- pneumatska podrška omogućuje udoban rad
- sigurna montaža i demontaža amortizera s McPherson sustavima opruga
- odgovara za 95% svih vozila na tržištu
- jednostavno i sigurno rukovanje



ZA 95% SVIH VOZILA



S PRILAGODNIK-PLOČOM

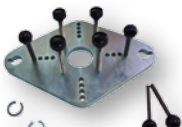

TEHNIČKI PODACI:

Radni tlak maks.:	10 bar
Priključni navoj:	1/4"
Potrošnja zraka:	250 l/min
Potisna snaga maks.:	1.200 kg
Izbačaj kompresije:	450,0 mm

8993,00* HRK

150.9545

SPECIJALNI POMOĆNI MONTAŽNI ALAT ZA AMORTIZERE-SET ZA AMORTIZERE SA VUČNOM OPRUGOM SA GRANIČNIKOM

- za demontažu i montažu amortizera i opruga sa vučnim graničnikom
- vučnu oprugu jednostavno potpuno izvući i sigurno i precizno podesiti
- minimalno uloženo vrijeme
- značajna minimizacija rizika prilikom zamjene opruga ili amortizera



7
-dijelni



1118,00* HRK

500.8755

UNIVERZALNI TELESKOPSKI CENTRIRANI ZATEZAČ-SET ZA UNUTARNJE OPRUGE

- za montažu i demontažu spiralnih opruga na poprečnim i upravljačkim osovinama
- sigurna ugradnja ili vađenje bez rastavljanja osovine
- nova, obrađena varijanta s produženim zateznim putem
- zaštita od preopterećenja pomoću torzijskog pogonskog elementa
- primjenjiv u vozilima s vrlo malim pristupnim rupama



9
-dijelni

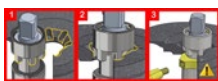

Ø 90-140 mm



Ø 75-115 mm



UKLJUČUJUĆI



TEHNIČKI PODACI:

kapacitet opruge:	1600 kg
tlak opruge maks.:	95,0 - 220,0 mm
maks. Opterećenje:	1600 kg

SIGURNOST NA PRVOM MJESTU

2243,00* HRK

*U cijene nije uračunat zakonom propisan porez na dodanu vrijednost.

150.1800

SUSTAV ZA PODEŠAVANJE PODVOZJA PUTNIČKIH VOZILA

- specijalno razvijena za primjenu na putničkim vozilima i transporterima s podjeljcima od 4 ili 5 rupa
- idealni za praktičnu montažnu pomoć prilikom radova popravaka dijelova upravljača ili podvozja na teretnim vozilima
- idealni za radove zamjene amortizera, kupolastih ležajeva ili opruga podvozja
- primjenjivi i prilikom zamjene glava spona, spona ili aksijalnog zgloba
- optimizacija procesa popravaka uslijed sada nepotrebnih skupih i dugotrajnih centriranja osovine



15
-dijelni

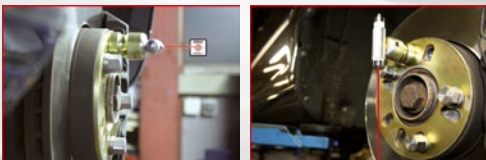
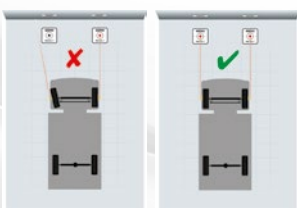

M12 x 1,5 mm

M14 x 1,5 mm



1343,00* HRK

150.1810

SUSTAV ZA PODEŠAVANJE PODVOZJA KAMIONA I TRANSPORTERA

- univerzalno primjenjivi, neovisno o rastojanju rupa ili broja klinova
- za radove popravaka dijelova upravljača i podvozja
- ponovno uspostavljanje polaznog stanja veličina za podešavanje kotača kao što su nagib i trag poslije popravka
- pri zamjeni dijelova podvozja, npr: glava spona (kuglasti zglob)

Područja primjene: primjena na transporterima, kamionima, autobusima, poluprikolicama i prikolicama



21
-dijelni



M18 x 1,5 mm

M16 x 1,5 mm

M20 x 1,5 mm

M14 x 1,5 mm

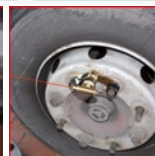
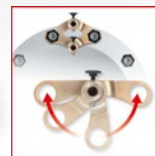

1568,00* HRK

150.1125

SPECIJALNI KLJUČ ZA AKSIJALNI ZGLOB-SET

- za demontažu aksijalnih zglobova na sponu
- primjenjivo na četverokutnim, šestierokutnim, osmerokutnim i okruglim vanjskim profilima
- vađenje bez oštećenja vanjske prirubnice zgloba
- snažan spoj
- za tijesne prostorne uvjete

KLJUČ USPJEHA POPRAVKE



4
-dijelni



30-35 mm



35-40 mm



40-45 mm

1/2"

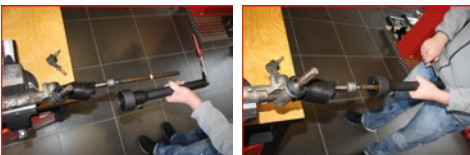

1/2" 32 mm

1193,00* HRK

*U cijene nije uračunat zakonom propisan porez na dodanu vrijednost.

500.8480

INDUKTIVNI GRIJNI PIŠTOLJ-SET

- za odvijanje zahrdalih i zapeklih spojeva
- za odvijanje „nerazdvojitih“ zalijepljenih spojeva
- točkasto zagrijavanje u nekoliko sekundi
- zagrijavanje dijelova do maks. 790°C (crveno užareno)

Područja primjene: vijci, matice i klinovi, obujmice ispušnih cijevi, t.j. cijevi, lambda sonde, zapekli ležajevi, kuglasti zglobovi, upravljač (npr. vijaka za podešavanje mjerenja osovine), navojni spojevi smješteni u kem. mikrokapsule (zalijepljeni), zagrijavanje sjedišta ležajeva prilikom montaže i demontaže

**NIJE SAMO
CIJENA VRUĆA!**

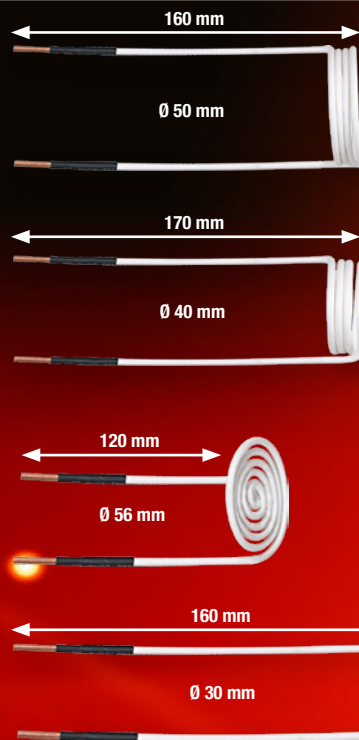
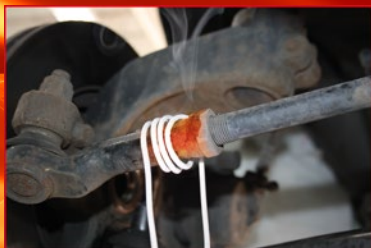

6
-dijelni



2993,00*
HRK

515.3880

VIBRO-IMPACT PNEUMATSKO ČEKIĆ DLIJETO-SET

- s neklizajućom Soft-Grip drškom
- primjenjivo u industriji
- učinkovito, pažljivo odvijanje navojnih spojeva
- s bezstupanjskom regulacijom broja udara
- prigušene vibracije

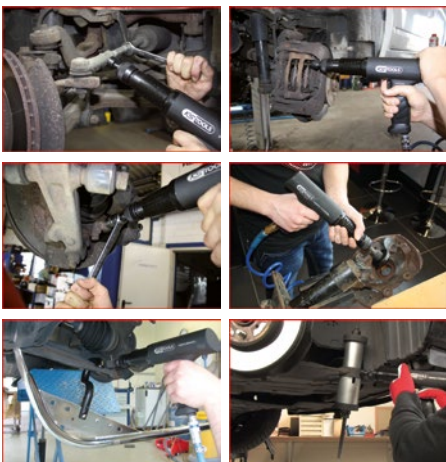

Taj vrši pritisak!

SA ZIDNIM DRŽAČEM



VIBRO-POWER



110 mm



110 mm



130 mm



100 x 25 x 12 mm



6
-dijelni

TEHNIČKI PODACI:

Prihvatač dlijeta:	10,2 mm
Radni tlak:	max. 6,3 bar (90 psi)
Potrošnja zraka:	114 l/min
Min. promjer crijeva:	3/8" - 10 mm

2243,00*
HRK

*U cijene nije uračunat zakonom propisan porez na dodanu vrijednost.

700.1550

POTISNE I VUČNE ČAHURE-SET

- za montažu i demontažu ležajeva
- idealno za silent ležaj, hidro ležaj, utičnice, kuglični ležaj, sigurnosni prsten itd.
- univerzalna primjena za putnička, teretna, komunalna vozila, poljoprivrednu i šumarsku tehniku itd.
- primjenjivo i u spoju sa radioničkom prešom ili cilindrom sa šupljim klipovima
- aksijalni ležaj štiti od povećanog trenja prilikom radnog postupka



37
-dijelni



3743,00* HRK

150.1840

ZATEZNI ALAT ZA SIGURNOSNI PRSTEN

- pod kutom od 90°
- za montažu i demontažu sigurnosnih prstena bez petlje
- neklizajuće
- krom vanadij

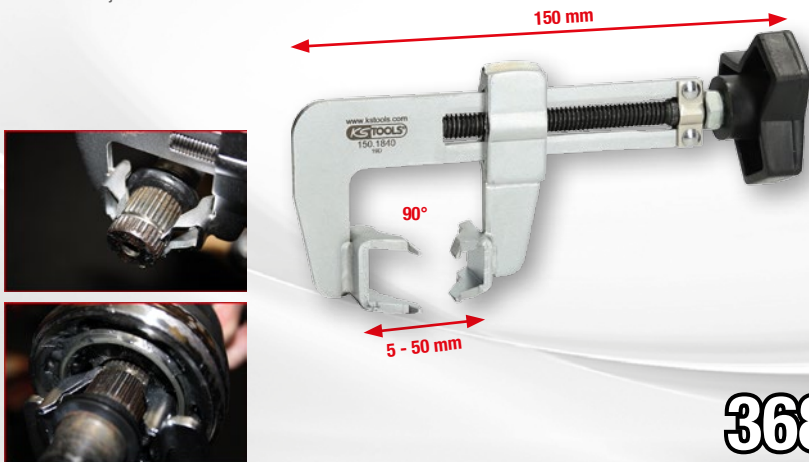

368,00* HRK

150.1736

12-IVIČNI SNAŽNI NASADNI KLJUČ ZA POGONSKE OSOVINE, TANKIH STRANICA

- 12-kutni
- konusnog oblika
- unutarnji kvadrat prema DIN 3120 / ISO 1174 s kugličnim žlijebom
- vrlo izdržljiva varijanta

Područja primjene: za Opel Corsa D, Adam, Mokka; Chevrolet Trax >2013; Fiat 500, Grande Punto, Punto Evo >2005; Ford Ka, Mercedes S-Klasse, BMW, Volkswagen i Jaguar XJ40, XJ181



143,00* HRK

150.2740

SET PROTUDRŽAČA ZA GLAVINU KOTAČA

- idealan za sigurno protudržanje prilikom montaže i demontaže centralnog vijka pogonskih osovina i navoja pogonske osovina na prijenosnik
- univerzalna primjena
- odgovara za skoro sva putnička vozila i male transportere
- odgovara za maks. M14 klinove / vijke kotača
- u stabilnom plastičnom koferu

SIGURNO PROTIV



6
-dijelni

668,00* HRK

*U cijene nije uračunat zakonom propisan porez na dodanu vrijednost.

700.1495

UNIVERZALNA POLUGA OSOVINE S LANCEM

- specijalna poluga za profesionalnu i pažljivu montažu i demontažu osovinskih dijelova
- fleksibilan lanac omogućuje sigurno potiskivanje poprečnih upravljača različitih modela bez velikog napora
- pažljiva i sigurna ugradnja i vađenje
- dodatna osoba nije potrebna
- velika ušteda snage i vremena i u slučaju ekstremne zategnutosti

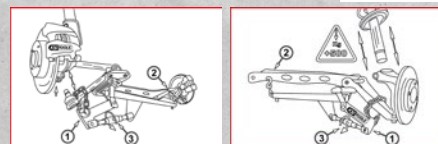

SAMOSTALNO RUKOVANJE

1118,00* HRK

515.3100

PNEUMATSKI MONTAŽNI UREĐAJ ZA MANŽETE OSOVINE

- odgovara za sve univerzalne i originalne manžete za osovine teretnih vozila
- odgovara i za vozila sa pogonom na sva četiri kotača i male transportere
- sa 8 izuzetno izdržljivih raširnih krakova
- komprimirani zrak se može dobro dozirati pomoću potisnog gumba
- dodatno sredstvo za podmazivanje nije potrebno



Uvijek u pokretu



TEHNIČKI PODACI:

Radni tlak:	max. 8 bar
Min. promjer crijeva:	3/8" - 10 mm
maks. raširni promjer:	25 - 115 mm

743,00* HRK

150.1467

REZAČ NAVOJA ZA VANJSKE NAVOJE M4 - M45

- za naknadno rezanje i čišćenje oštećenih vanjskih navoja
- odgovara i za desni i za lijevi navoj
- bezstupanjski podesivo preko vijka s reznom glavom
- zahvaljujući širini čeljusti rezač se može dobro voditi i ne može se prevrnuti
- može se primijeniti svuda neovisno o dužini navoja

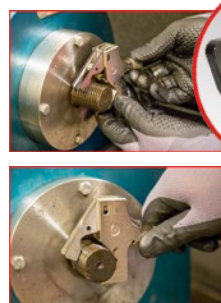

M4 - M45

368,00* HRK

300.0540

DIGITALNI KLIZNI MJERAČ KOČIONIH DISKOVA 0 - 60 MM

- prema DIN 862
- za unutarnja mjerenja
- mm/col prebacivanje
- reset (nuliranje) moguć na svim pozicijama
- veliki LCD indikator - visina znamenki 10,0 mm



357,00* HRK

*U cijene nije uračunat zakonom propisan porez na dodanu vrijednost.

150.2299

**ALAT ZA OPRUGE ČELJUSTI
RUČNE KOČNICE ZA MERCEDES**

- idealno za montažu i demontažu opruge držača na čeljustima ručne kočnice disk kočnica
- prorez za vođenje u području funkcije
- omogućava jednostavan prilaz oprugama iza glavine
- za tjesne prostorne uvjete

Područja primjene: opruge ručne kočnice (disk kočnica straga) za Mercedes V klase Vito i Viano (tip 638) 1996 - 2003, (tip 639) 2003 - 2014, (tip 447) >2014



143,00* HRK

150.1935

**SET UNIVERZALNIH KUKA, MOGU
SE OBLIKOVATI**

- univerzalna primjena
- može se oblikovati po želji (fleksibilno)
- ove kuke sprječavaju da težina tijela kočnice ošteti kočiona crijeva
- svjetleća signalna boja se optički odmah opaža i sprječava da ih se zaboravi u vozilu
- oblik ostaje održan i može se u svakom trenutku promijeniti



72,00* HRK



2
-dijelni

104.5065

**REZAČ KOČIONIH VODOVA S
USTAVLJAČEM**

- za brzo i lako rezanje kočionih vodova
- vrlo dobro vođenje uslijed široke površine nalijeganja jamči kutni rez
- automatsko samopodešavanje za brže rezanje
- odgovara za tjesne prostore, i ispod vozila
- izdržljiv ustavljački mehanizam



218,00* HRK



150.2237

**PNEUMATSKO VRETENO ZA PRILAGODNIK KOČIONIH
KLIPOVA ZA USKE PROSTORE**

- odgovara za sužene prostore zahvaljujući optimiziranoj protuploči
- idealno za vraćanje kočionih klipova bez oštećenja
- smjer okretanja određuje korisnik preko kutnika na kraju vretena
- komforan i brz rad pomoću pneumatskog vretena
- potrebno tijekom radova održavanja i prilikom zamjene kočionih blokova za protiskanje kočionih klipova natrag u tijelo kočnice

**NEOPHODNO ZA
SERVIS KOČNICA**

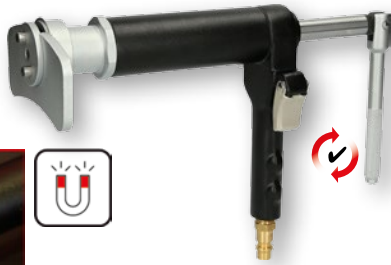
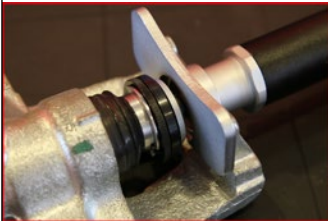

518,00* HRK



150.2295

**SET UNIVERZALNIH PRILAGODNIKA ZA ALAT ZA VRAĆANJE
KOČIONIH KLIPOVA**

- s jedinstveno podesivim 2-pinskim i 3-pinskim univerzalnim prilagodnicima kočionih klipova i 3/8" prilagodnikom s magnetom
- idealno za vraćanje kočionih klipova bez oštećenja
- bez oštećenja manžeti, klipova i rupa za klipove u tijelu kočnice
- potrebno tijekom radova održavanja i prilikom zamjene kočionih blokova za protiskanje kočionih klipova natrag u tijelo kočnice
- može se kombinirati s uobičajenim alatom za vraćanje kočionih klipova

**SUPER FLEKSIBILNO ZAHVALJUJUĆI
2-PINSKIM I 3-PINSKIM
PRILAGODNICIMA**



Odgovara za skoro sva vozila

293,00* HRK



3
-dijelni

122.1290

FLAREFIX 1 UNIVERZALNI ALAT ZA RUBOVE VODOVA KOČNICA SA HIDRAULIČNO VRETENO

- lagano i lako za rukovanje
- omogućuje primjenu izravno na vozilu
- bez oštećenja obloženih vodova
- za čelične, aluminijske i bakrene vodove tankih zidova
- brzi i precizni rezultati rada uslijed pravolinijskog kretanja uređaja za obradu rubova

**SVE ZA KOČIONE
PROVODNIKE**



FLAREFIX

1118,00* HRK



16
-dijelni

*U cijene nije uračunat zakonom propisan porez na dodanu vrijednost.

122.1215

FLAREFIXeco 4,75 MM UNIVERZALNI SET UREĐAJA ZA OBRADU RUBOVA

- lagano i lako za rukovanje
- omogućuje primjenu izravno na vozilu
- bez oštećenja obloženih vodova
- za univerzalnu primjenu u radionicama za teretna vozila
- za čelične, aluminijske i bakrene vodove tankih zidova



4
-dijelni

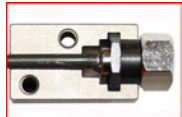

**PRIMJENA
IZRAVNO
NA VOZILU**



368,00*
HRK

160.0710

UNIVERZALNI PRILAGODNICI OTVORA ZA ODZRAČIVANJE-SET ZA ODZRAČIVANJE KOČNICA

- primjenjivo u spoju sa uređajima za održavanje kočnica
- lako i brzo rukovanje
- specijalna brtva za kočionu tekućinu
- odgovara za > 98% svih tipova vozila
- neophodno u svakoj radionici za teretna vozila



4
-dijelni

**OBAVEZAN DIO
SVAKE RADIONICE**

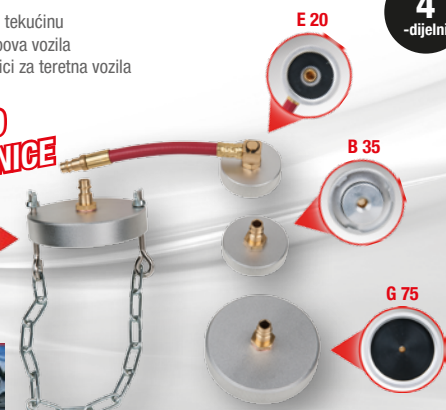
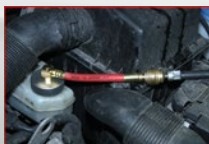

1118,00*
HRK

100.5075

SET BRUSILICA ZA GLAVINU KOTAČA, Ø 150 MM, UNUTARNJI Ø 90 MM

- za optimalno čišćenje glavina kotača i kočionih diskova
- idealno primjenjivo za glavine kotača putničkih vozila, transportera i velikih limuzina Ø 150 mm promjerom
- optimizirano za najnovije glavine kotača s povećanim unutarnjim promjerom (Ø 90 mm)
- bez iskrenja
- sprječava pomicanje okretnog momenta zatezanja kotača zahvaljujući čistoj kontaktnoj površini



2
-dijelni



400,00*
HRK

160.0725

SET KLJUČEVA ZA ODZRAČIVANJE KOČNICA

- idealno za teško pristupačna mjesta prilikom odzračivanja kočnica
- za odzračivanje kočnica bez demontaže kotača
- s nepovratnim ventilom koji sprječava vraćanje protoka stare kočione tekućine te ispumpanog zraka
- odgovara i za odzračivanje sustava spojnica
- ekstra kratko 12-kutni nasadni ključevi



6
-dijelni

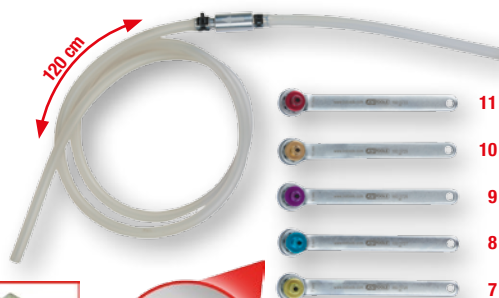
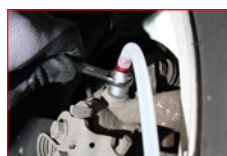

593,00*
HRK

150.9524

KLJUČ ZA FILTAR ZA ULJE Ø 74,5 MM / 15 PVRŠINA

- za brzu i profesionalnu montažu i demontažu teško pristupačnih patrona filtra
- za zatezanje s preciznim okretnim momentom prema navodima proizvođača
- odgovara za lijevi i desni pogon
- unutarnji četverokutni pogon prema DIN 3120 / ISO 1174



Područja primjene: Ford Focus 3, C-Max 2, Galaxy 3, Kuga 2, Mondeo 4, Mondeo 5, S-Max 2, Transit Connect 2 itd. s 1,5 l i 1,6 l EcoBoost benzinskim motorima



Ø 74,5 mm
15 površina

188,00*
HRK

150.9543

KLJUČ ZA FILTAR ZA ULJE Ø 84 MM / 14 PVRŠINA

- za brzu i profesionalnu ugradnju i vađenje poklopca filtra za ulje prilikom zamjene uloška filtra za ulje
- za zatezanje s preciznim okretnim momentom prema navodima proizvođača
- odgovara za lijevi i desni pogon
- unutarnji četverokutni pogon prema DIN 3120 / ISO 1174



Područja primjene: Mercedes C klase (320), CLS (320), E klase (280, 320), ML (280, 320) itd. s CDI motorima (šifra motora: OM642)



Ø 84 mm
14 površina

218,00*
HRK

150.9317

KLJEŠTA ZA FILTAR ZA ULJE

- s izoliranom ručkom
- 5-struko podeseivo
- univerzalna primjena
- specijalni zupci za hvatanje na čeljustima
- sigurno držanje na vanjskom promjeru



50 - 125 mm

290 mm

135,00*
HRK

*U cijene nije uračunat zakonom propisan porez na dodanu vrijednost.

913.1460

TERETNI NASADNI KLJUČ SPIRALNOG PROFILA-SET

- unutarnji kvadratni pogon prema DIN 3120 / ISO 1174 s kugličnim žlijebom
- kupasti specijalan profil s agresivnim spiralnim zasjecima
- za odvijanje vijaka s okruglo zavijenim glavama
- snažan spoj između nasadnog ključa i glave
- s trnom za vađenje



15
-djelni

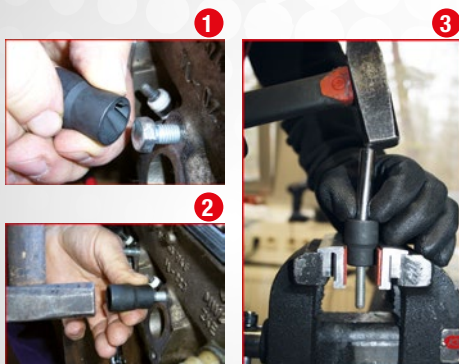

NAPADA OKRUGLE GLAVE

1043,00* HRK

300.0537

MJERAČ DUBINE PROFILA GUMA 0 - 30 MM

- očitavanje bez zasijepijavanja
- za mjerenja dubine
- očitavanje u 0,1 mm koracima za precizno utvrđivanje dubine profila
- izdržljiva varijanta
- od čvrstog mesinga

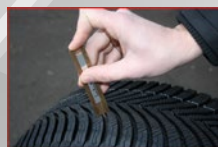
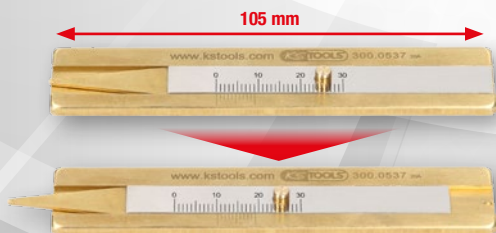

OD ČVRSTOG MESINGA

90,00* HRK

160.0391-TD

SET UNIVERZALNIH GUMENIH PODLOGA ZA PODIZNE PLATFORME

- idealna podloga za zaštitu pragova i laka
- optimalna sigurnost od klizanja
- univerzalna podloga za podizne platforme
- optimalno za radionice za karoserije, podizne platforme za servisiranje guma itd.
- vrlo izdržljivo i time višestrano primjenljivo



4
-djelni

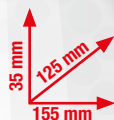

218,00* HRK

913.1484

SET ALATA ZA BUŠENJE BRAVE NAPLATAKA

- za brzo i jednostavno bušenje i otpuštanje brava na felnama
- idealno za brave na naplaticima s rotacijskim vanjskim omotačem
- sprječava veća oštećenja na aluminijskim naplaticima
- s centrirnom čahurom, svrdlom i ekstraktorima
- s pomoćnim elementom i skidačem ekstraktora

- 2 x Svrdla, Ø 8,5 mm
- 3 x Centrirna čahura, metalna, unutarnji Ø 19 - 21 - 24 mm
- 4 x Centrirni konus, najlon, vanjski Ø 33 - 35 - 37 - 38 mm
- 1 x Pomoćni element za udaranje
- 4 x Ekstraktor
- 1 x Alat za uklanjanje ekstraktora
- 1 x Čahura za odvrtnanje 17 - 19 mm



16
-djelni



ŠTITI VAŠE NAPLATKE!



I ZA BRAVE NAPLATAKA S ROTACIJSKOM VANJSKOM ČAHUROM



1493,00* HRK

*U cijene nije uračunat zakonom propisan porez na dodanu vrijednost.

STANDARD

12V
SPECIAL

150.1070

VULKANIZERSKI SET ZA MOTORNA VOZILA

- jednostavno rukovanje
- izdržljiv metalni alat
- idealno za popravku ubodnih oštećenja na površinama guma bez unutarnjeg crijeva
- sadrži sve potrebne alate za popravku

Područja primjene: putnička vozila, motori, transporteri, velike limuzine

**UKOLIKO NEKADA
OSTANETE BEZ ZRAKA**



5
-dijelni



Pribor:

150.1072 Rezervni konac, 100mm, pakiranje s 60 kom HRK 113,00

368,00* HRK

515.2095

SET ZA VULKANIZACIJU THE DEVIL



6
-dijelni



1600 Nm

40-200 Nm



sa pregledni znak
DIN EN ISO 6789
Sertifikat
tačnost ±3%

1/2"



slimPOWER



1343,00* HRK

*U cijene nije uračunat zakonom propisan porez na dodanu vrijednost.

3
-dijelni

Za velike poznavatelje

SET PRIBORA

11100 **113,00** HRK*

KS TOOLS SET ALATA ZA DJECU

- Igračka s realističnom funkcijom: S ovim super KS Tolls setom alata mali zanatlija može početi s radom i ni na koji način neće zaostajati za profesionalcom
- Razvoj sposobnosti: vizualno i manualno, mozak, hvatanje, intelektualni razvoj, senzorna percepcija, slušanje, vježba sposobnosti, koordinacija očiju i ruku,...
- Širok asortiman: Dječji set sadrži svrdlo, aku odvijač, kliješta, čekić, ključ za vijke, pilu,...
- Realističan dizajn: Aku odvijač, koji radi na baterije (baterije nisu sadržane), može se koristiti s dva različita svrdla

Preporučeni uzrast: 3 do 8 godina. Nije namijenjeno djeci mlađoj od 36 mjeseci. Opasnost od gušenja malim dijelovima koji se mogu progutati.

Za male zanatlije



100073 **132,00** HRK*

Vaš partner

AUTO HRVATSKA PSC

Auto Hrvatska Prodajno servisni centri d.o.o.
Zastavnice 25c, Hrv. Leskovac, 10257 Brezovica
mail: alati@autohrvatska.hr
tel: 01/6167 621

PREMIUM-WERKZEUGE

KS TOOLS
PREMIUM TOOLS

KS Tools Werkzeuge - Maschinen GmbH

Seligenstädter Grund 10 - 12
D-63150 Heusenstamm

NJEMAČKA

Tel.: +49(0) 61 04 49 74-0

Fax: +49(0) 61 04 49 74-11

e-mail: kstools@kstools.de

www.kstools.com



LL20-02HR_KUNA

*Po ovdje ponudenoj posebnoj cijeni - sve do isteka zaliha.

U cijene nije uračunat zakonom propisan porez na dodanu vrijednost. Objavljujemo ovaj prospekt s prethodno objavljene cijene prestaju vrijediti. Prodaja samo specijaliziranim prodavaonicama. Zadržano pravo na tiskarske pogreške, propuste i tehničke izmjene. Cijene vrijede do 31.03.2021